

MOTOR POWER

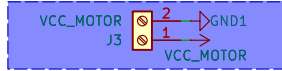

2V5>3V3

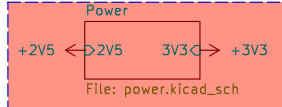

OLIMEX CONNECTOR

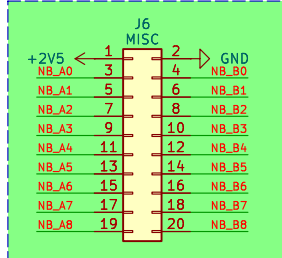

MOTOR1 ENCODER

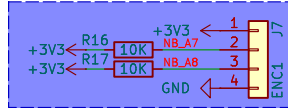

TB6612FNG MOTOR1

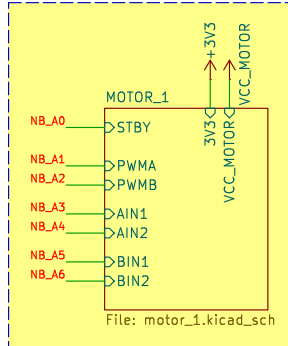

MOTOR2 ENCODER

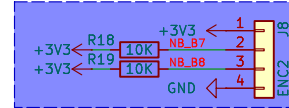

TB6612FNG MOTOR2

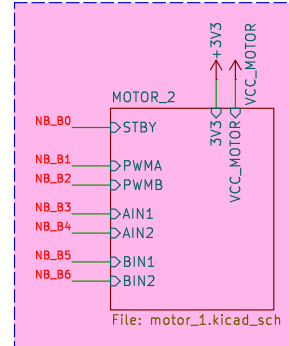

POWER FLAGS

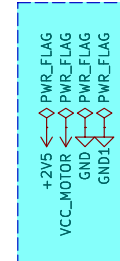

Intergalaktik d.o.o.

Sheet: /

File: pwrIO.kicad_sch

Title: Motor driver board

Size: A5

Date: 2024-11-26

KiCad E.D.A. 8.0.4

Rev: v0.1

Id: 1/4

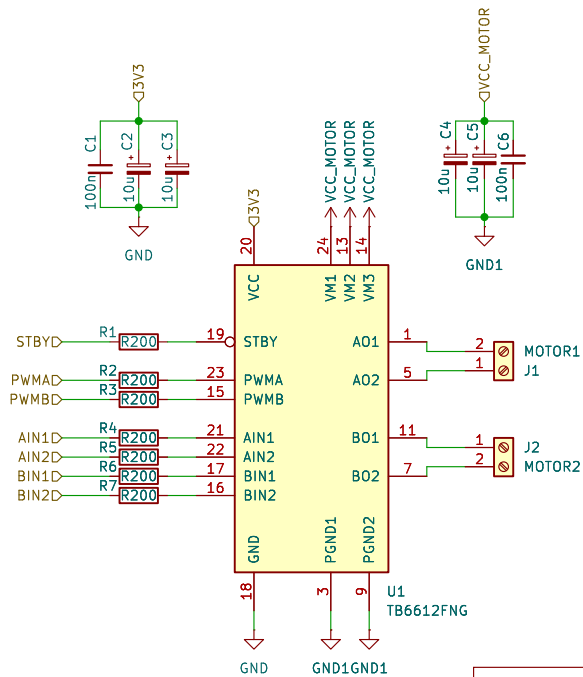

Intergalaktik d.o.o.

Sheet: /MOTOR_1/

File: motor_1.kicad_sch

Title: Motor driver board

Size: A5

Date: 2024-11-26

Rev: v0.1

KiCad E.D.A. 8.0.4

Id: 2/4

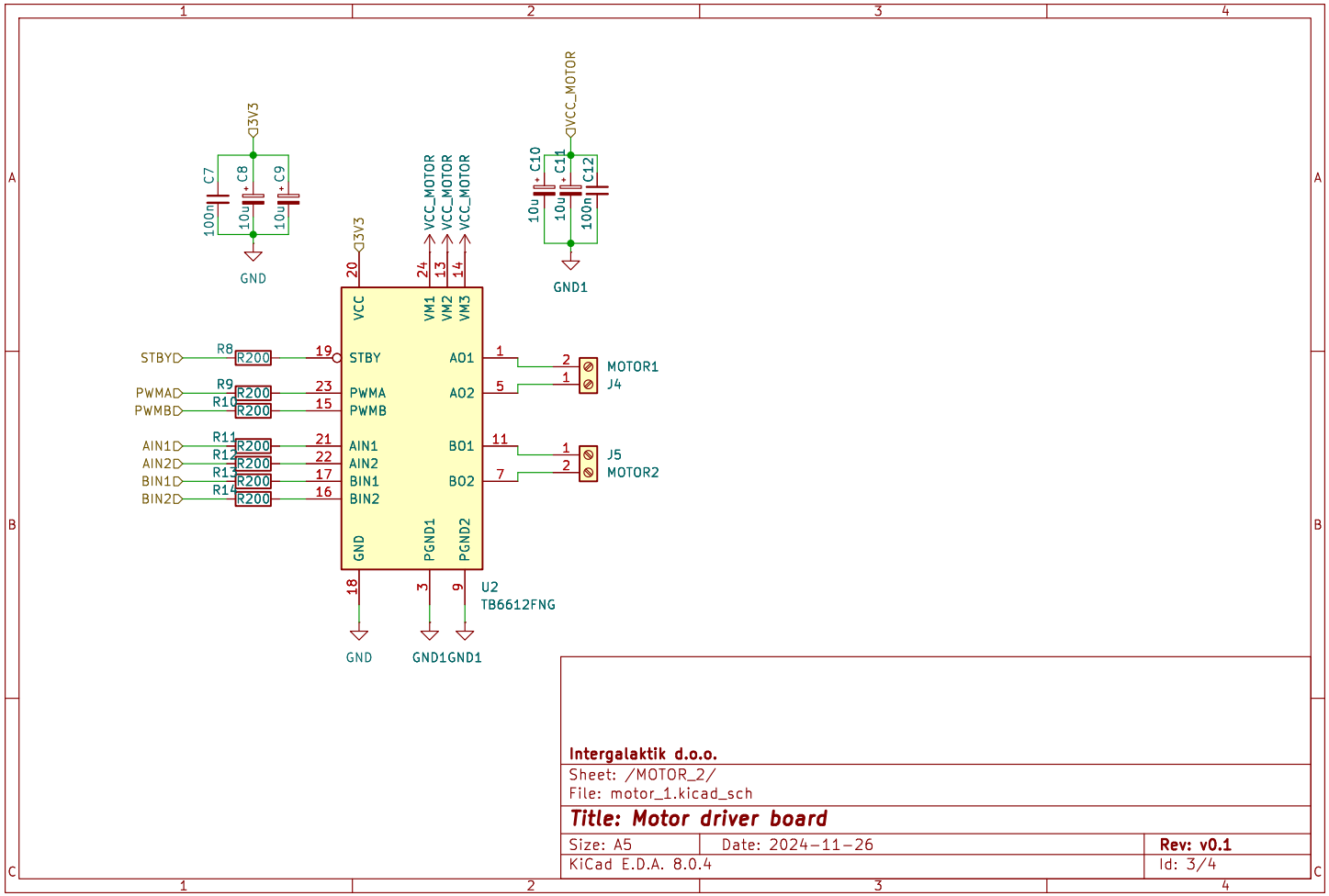

Intergalaktik d.o.o.	
Sheet: /MOTOR_2/	
File: motor_1.kicad_sch	
Title: Motor driver board	
Size: A5	Date: 2024-11-26
KiCad E.D.A. 8.0.4	Rev: v0.1 Id: 3/4

StepUp 2V5>>3V3

Up to 300-mA Output Current
1-MHz Fixed-Frequency PWM Operation

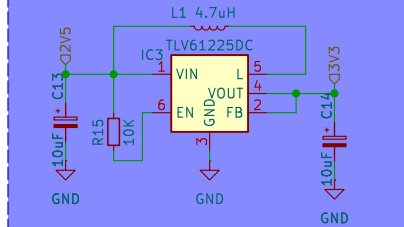

Intergalaktik d.o.o.

Sheet: /Power/

File: power.kicad_sch

Title: Motor driver board

Size: A5

Date: 2024-11-26

KiCad E.D.A. 8.0.4

Rev: v0.1

Id: 4/4