



BOSCH

Operating Instructions

Hydronic Gas Condensing Boiler

Condens 5000 W

ZSB 30-2 A ...| ZWB 37-2 A ...

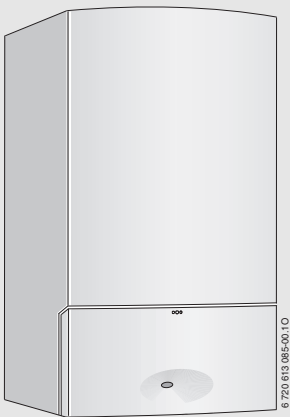

Contents

1	Explanation of symbols and safety instructions	3
1.1	Explanation of symbols	3
1.2	General safety instructions	4
2	Product details	10
2.1	Declaration of conformity	10
2.2	Explanation of model code	10
3	Preparing the appliance for use	11
3.1	Turn on the gas service cock	11
3.2	Turn on the isolators	12
3.3	Opening the control panel cover	13
3.4	Check the central heating system pressure	14
3.5	Top up the heating system	15
4	Operation	16
4.1	Overview of controls	18
4.2	Switching the appliance on/off	20
4.3	Starting the central heating	21
4.4	Setting the heating control unit	23
4.5	Appliances with hot water cylinder: setting the hot water temperature	24
4.6	ZWB appliances - setting hot water temperature	26
4.7	Summer mode (central heating off, DHW only)	28
4.8	Frost protection	29
4.9	Holiday mode	30
4.10	Further displays	31
5	Carry out thermal disinfection	32

6	Tips on saving energy	34
7	Troubleshooting	36
8	Maintenance	37
9	Environment / disposal	38
10	Operating instructions quick reference	39

1 Explanation of symbols and safety instructions

1.1 Explanation of symbols

Warnings

In warnings, signal words at the beginning of a warning are used to indicate the type and seriousness of the ensuing risk if measures for minimising danger are not taken.

The following signal words are defined and can be used in this document:

- **DANGER** indicates that severe or life-threatening personal injury will occur.
- **WARNING** indicates that severe to life-threatening personal injury may occur.
- **CAUTION** indicates that minor to medium personal injury may occur.
- **NOTICE** indicates that material damage may occur.

Important information



This symbol indicates important information where there is no risk to people or property.

Additional symbols

Symbol	Explanation
▶	a step in an action sequence
→	a reference to a related part in the document
•	a list entry
–	a list entry (second level)

*Table 1***1.2 General safety instructions****Instructions for the target group**

These operating instructions are intended for the heating system user.

All instructions must be observed. Failure to comply with instructions may result in material damage and personal injury, including possible loss of life.

- ▶ Read and retain the operating instructions (heat source, heating controller, etc.) prior to operation.
- ▶ Observe the safety instructions and warnings.

Determined use

The product may only be used for the heating of boiler water and for DHW heating.

Any other use is considered inappropriate. We assume no liability for damage occurring due to non-permitted use.

If you smell gas

A gas leak could potentially cause an explosion. If you smell gas, observe the following rules.

- ▶ Prevent flames or sparks:
 - Do not smoke, do not use a lighter or strike matches.
 - Do not operate any electrical switches or unplug any equipment.
 - Do not use the telephone or ring doorbells.
- ▶ Turn off the gas supply at the main shut-off valve or at the gas meter.
- ▶ Open windows and doors.
- ▶ Warn your neighbours and leave the building.
- ▶ Prevent anyone from entering the building.
- ▶ Move well away from the building: call the emergency services and the gas supplier.

Danger to life from poisoning by flue gas

There is a danger to life from escaping flue gas.

- ▶ **Never modify any parts through which flue gas is routed.**

If flues are damaged or leaking, or if you smell flue gas, observe the following rules.

- ▶ Switch off the heat source.
- ▶ Open doors and windows
- ▶ Warn your neighbours and leave the building immediately.
- ▶ Prevent third parties from entering the building.
- ▶ Notify an approved contractor.
- ▶ Have any defects rectified.

Danger to life from carbon monoxide

Carbon monoxide (CO) is a poisonous gas, which arises during the incomplete combustion of fossil fuels such as oil, gas or solid fuels.

Dangers arise, if carbon monoxide escapes from the heating system due to a fault or a leak and collects unnoticed in enclosed spaces.

You can neither see, taste nor smell carbon monoxide.

To avoid danger from carbon monoxide:

- ▶ Have the heating system inspected and serviced regularly by an approved contractor.
- ▶ Use a CO detector, which gives an alarm in good time if CO escapes.
- ▶ If you suspect a CO leak:

- Warn your neighbours and leave the building immediately.
- Call an approved contractor.
- Have any defects rectified.

Inspection and maintenance

If there is a lack of cleaning, inspection or maintenance, or if these are carried out incorrectly, this may result in material damage and/or personal injury, including possible loss of life.

- ▶ Have work carried out only by an approved contractor.
- ▶ Have any defects rectified immediately.
- ▶ Have the heating system inspected once a year by an approved contractor, and have any required maintenance or cleaning work carried out.
- ▶ Have the heat source cleaned at least every two years.
- ▶ We recommend that you enter into a contract covering an annual inspection and needs-based maintenance with an approved contractor.

Conversion and repairs

Improper modifications to the heat source or other parts of the heating system can result in personal injury and/or material damage.

- ▶ Have work carried out only by an approved contractor.
- ▶ Never remove the casing of the heat source.
- ▶ Never carry out any modifications to the heat source or to other parts of the heating system.
- ▶ Never close the outlet of the pressure relief valves. Heating systems with DHW cylinder: During heat-up, water can escape from the pressure relief valve of the DHW cylinder.

Open flue operation

The installation location must be adequately ventilated, if the heat source draws its combustion air from the room.

- ▶ Never cover or reduce the size of ventilation openings in doors, windows and walls.
- ▶ Consult a contractor to ensure that ventilation requirements are met:
 - If structural modifications are made (e.g. replacing windows and doors)

- If devices with an air discharge to the outside are subsequently installed (e.g. extractor fans, kitchen fans or air conditioning units).

Combustion air/ambient air

The air in the installation location must be free of flammable or chemically aggressive substances.

- ▶ Do not store or use any highly flammable or explosive materials (paper, petrol, thinners, paints etc.) within the vicinity of the heat source.
- ▶ Do not store or use any corrosive substances (solvents, adhesives, chlorinated cleaning agents, etc.) within the vicinity of the heat source.

Condensate tube

Condensate is produced in this wall mounted gas condensing boiler and removed via a condensate tube. Modification or blocking of the condensate tube is not permitted.

2 Product details

2.1 Declaration of conformity

The design and operating characteristics of this product comply with the European and national requirements.

 The CE marking declares that the product complies with all the applicable EU legislation, which is stipulated by attaching this marking.

The complete text of the Declaration of Conformity is available on the Internet: www.bosch-climate.com.au.

2.2 Explanation of model code

Condens 5000 W	ZSB 30-2 A
	ZWB 37-2 A

Table 2

Z	Central heating appliance
S	Cylinder connection
W	DHW heating
B	Condensing boiler technology
30	Output up to 30 kW
37	DHW output up to 37 kW
-2	Version
A	Fan-assisted appliance without draught hood

3 Preparing the appliance for use

3.1 Turn on the gas service cock

- ▶ Using a screwdriver, turn the square tap handle so that the slot is in line with the direction of flow.
- Slot at right-angles to direction of flow = off.

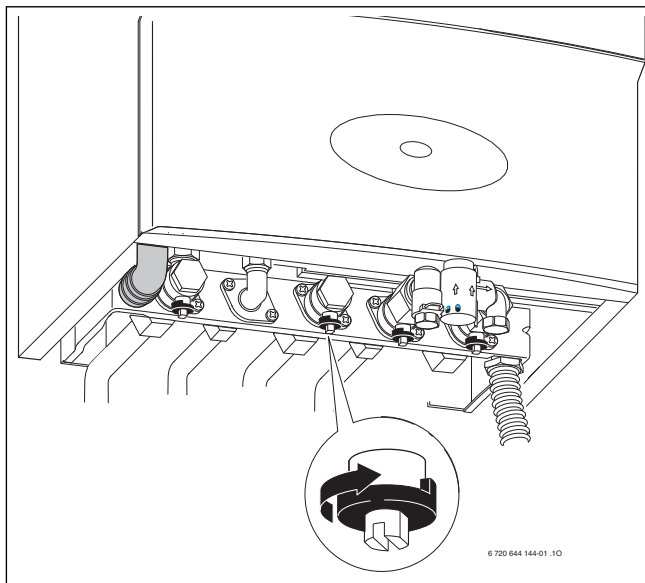

Fig. 1

3.2 Turn on the isolators

- ▶ Using a screwdriver, turn the square tap handle so that the slot is in line with the direction of flow.

Slot at right-angles to direction of flow = off.

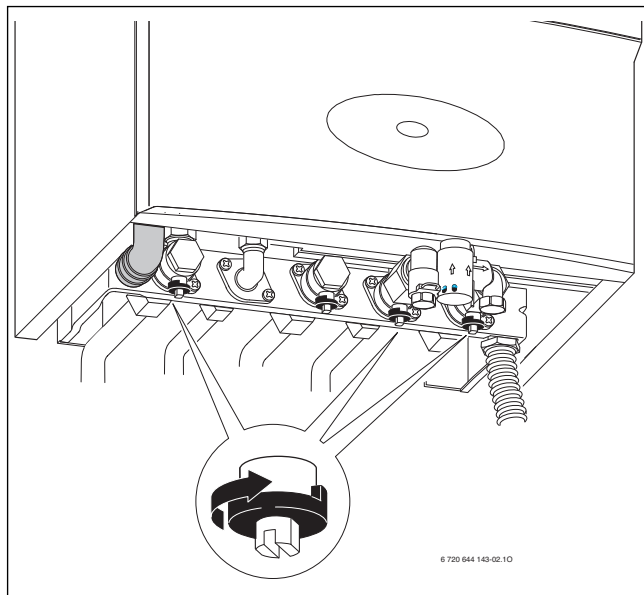

Fig. 2

3.3 Opening the control panel cover

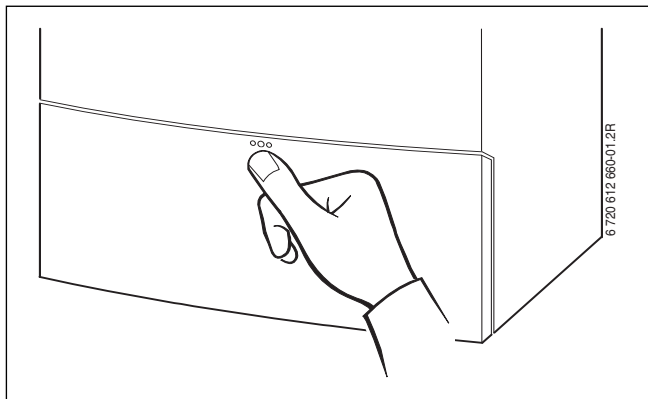

Fig. 3

3.4 Check the central heating system pressure

The normal operating pressure is 1 - 2 bar.

If a higher setting is required, you will be informed by your installer.

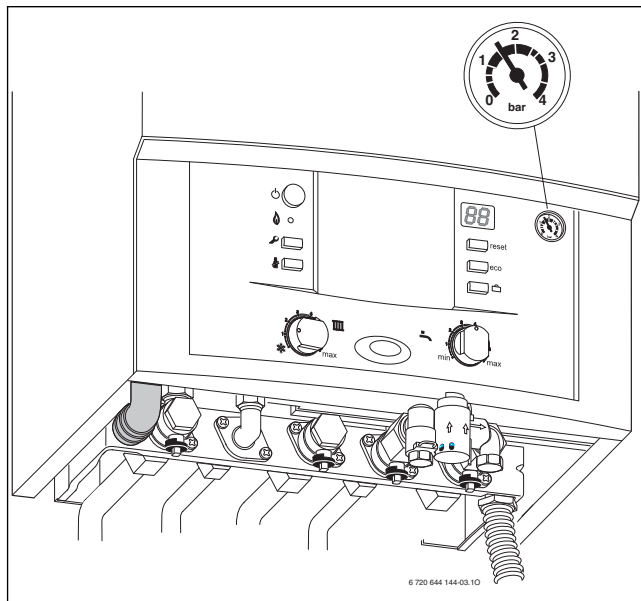

Fig. 4

3.5 Top up the heating system

The way in which the heating system is topped up is different on every system. Therefore, you should ask your installer to show you how it is done.



CAUTION: Risk of damaging the appliance.

- ▶ Only top up the heating system when the appliance is cold.

Maximum pressure of 3 bar at maximum heating water temperature must not be exceeded (safety valve will open).

4 Operation

These Operating Instructions apply only to the boiler.

Depending on the heating controller used, some functions may be controlled differently.

The following possibilities for controlling the heating system may be employed:

- weather-dependent controller built into the boiler → page 18, item 7.
- weather-dependent controller external to the appliance
- room thermostat



Therefore, please read the operating instructions for the heating controller used.



Page 39 contains brief operation instructions. You can fold this outwards and push the operating instructions into the appliance facia for safekeeping.

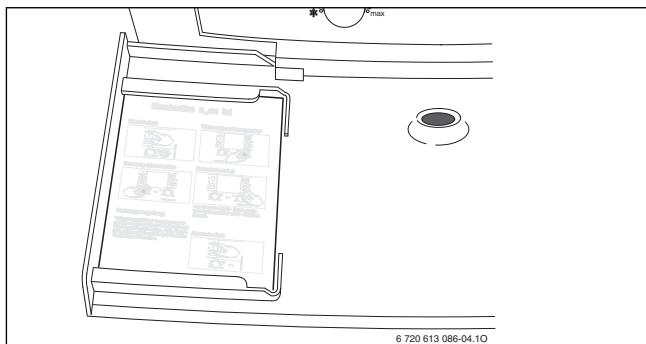

Fig. 5

4.1 Overview of controls

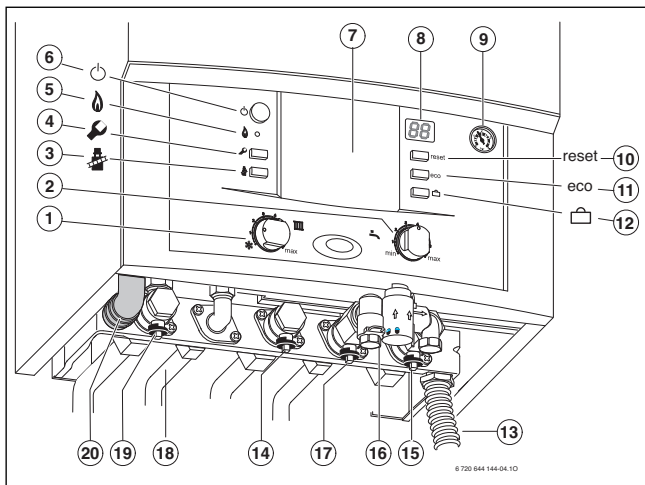

Fig. 6

- [1] Flow temperature control
- [2] DHW temperature control
- [3] Chimney sweep button
- [4] Service button
- [5] Burner ON indicator
- [6] Main switch
- [7] Here, a weather-compensated control unit or a time switch (accessories) can be plugged in
- [8] Display
- [9] Pressure gauge
- [10] reset button
- [11] eco button
- [12] Holiday button
- [13] Drain from pressure relief valve (heating circuit)
- [14] Gas tap
- [15] CH return isolator
- [16] Filling loop (ZWB)
- [17] Cold water tap (ZWB),
cylinder return (ZSB)
- [18] DHW connection (ZWB),
cylinder flow (ZSB)
- [19] CH flow isolator
- [20] Condensate hose

4.2 Switching the appliance on/off

Switching on

- ▶ Switch appliance on at the main switch.
The display shows the heating water flow temperature.

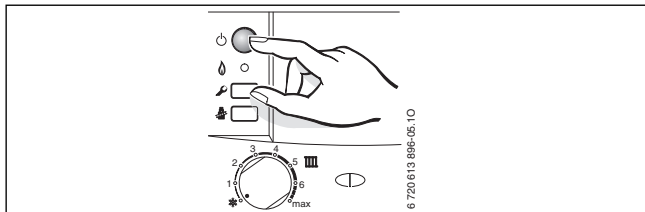



Fig. 7



If the display  shows alternately with the flow temperature, the appliance will operate with the lowest output for 15 minutes.

Switching off the appliance

- ▶ Switch appliance off at the main switch.
The display goes out.
- ▶ If the appliance is to be switched off for a longer period of time: observe correct frost protection procedures (→ Section 4.8).

4.3 Starting the central heating

The maximum flow temperature can be matched to the heating system by the flow temperature controller. The current flow temperature is shown on the display.

Setting on flow temperature controller 	Flow temperature	Sample application
1	Approx. 35 °C	
2	Approx. 43 °C	
3	Approx. 50 °C	Underfloor heating system
4	Approx. 60 °C	
5	Approx. 67 °C	
6	Approx. 75 °C	Radiator heating system
max.	Approx. 90 °C	Convactor heating system

Table 3



With underfloor heating systems, take care to observe the maximum permissible CH flow temperatures.

- Turn flow temperature controller  to adjust the maximum flow temperature.

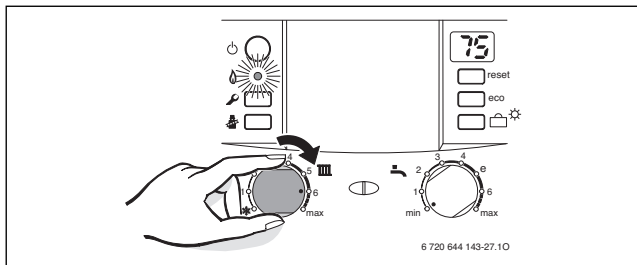

Fig. 8

When the burner is firing, the green indicator lamp lights up.

4.4 Setting the heating control unit



Follow the operating instructions for the heating controller used. Those instructions will tell you

- ▶ how to set the operating mode and the heating curve for weather-dependent controllers,
- ▶ how to adjust the room temperature,
- ▶ how to heat economically and save energy.

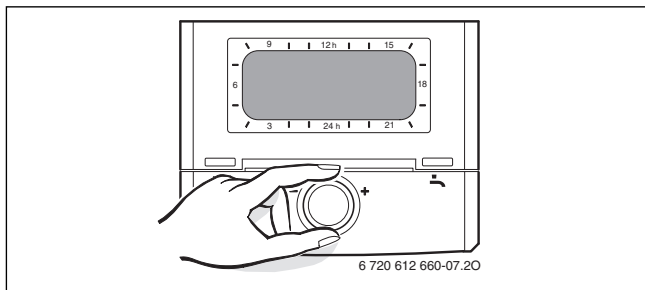



Fig. 9

4.5 Appliances with hot water cylinder: setting the hot water temperature



WARNING: Danger of scalding!

- ▶ In normal operation, do not set the temperature higher than 60 °C.

- ▶ Set the DHW temperature on the DHW temperature control . The set DHW temperature flashes on the display for 30 seconds.

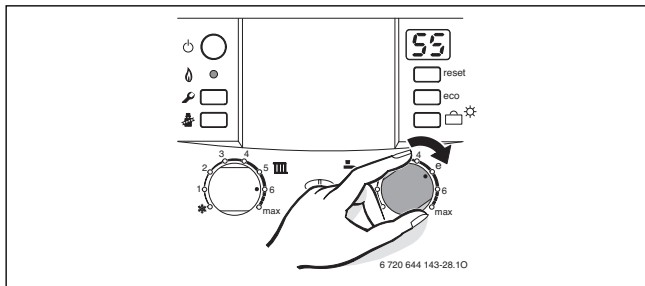



Fig. 10



To prevent bacterial contamination such as legionella, we recommend setting the DHW temperature controller  to “6” (60 °C).

DHW thermostat 	DHW temperature
min	Approx. 5 °C (frost protection)
e	Approx. 55 °C
6	Approx. 60 °C
max.	Approx. 70 °C

Table 4

eco button

Pressing and holding the eco button until it lights up switches between **Comfort mode** and **Economy mode**.

Comfort mode, Eco button is not lit (default setting)

In Comfort mode, the hot water cylinder has priority. The hot water cylinder is heated to the set temperature first. Then the appliance switches to central heating mode.

Economy mode, Eco button lit

In Economy mode, the appliance switches between central heating mode and hot water mode every ten minutes.

4.6 ZWB appliances - setting hot water temperature

- ▶ Set the DHW temperature on the DHW temperature control . The set DHW temperature flashes on the display for 30 seconds.

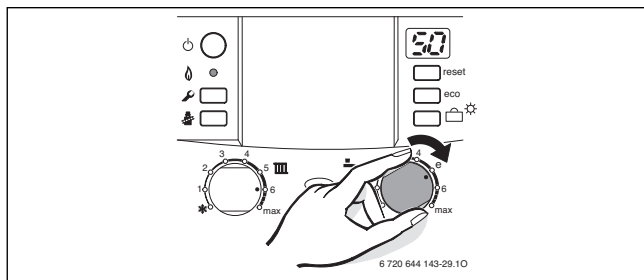

Fig. 11

DHW thermostat 	DHW temperature
min	Approx. 40 °C
e	Approx. 50 °C
max.	Approx. 60 °C

Table 5

eco button

Pressing and holding the eco button until it lights up switches between **Comfort mode** and **Economy mode**.

Comfort mode, (Eco button is not lit - default setting)

The appliance is held **constantly** at the set temperature. This means that hot water is available almost instantaneously at the tap.

Consequently the appliance will switch on at intervals, even if no hot water is being drawn.

Economy mode, Eco button lit





If a start delay for the supply of water preheated by solar energy has been set (service function b.F), the appliance does not switch on until the start delay has elapsed.

- The water is not heated up until a hot water tap is turned on.
 - **With a demand signal** (only with start delay switched off for the supply of water preheated by solar energy). Briefly turning a hot water tap on and then off signals demand so that the water is then heated up to the set temperature.
-



The demand signal enables gas and water savings.

4.7 Summer mode (central heating off, DHW only)

- ▶ Note position of CH flow temperature control .
- ▶ Turn CH flow temperature control  anti-clockwise as far as the stop . The heating circuit pump and consequently central heating are switched OFF. However, the DHW supply as well as the power supply to the heating programmer and timer remain 'live'.

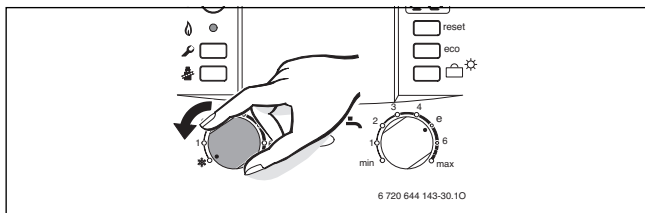

Fig. 12



NOTICE: Heating system at risk from frost.

Additional instructions are contained in the operating instructions for the heating programmer.

4.8 Frost protection

Frost protection for the heating system:

- ▶ Leave appliance switched on, set CH flow temperature control  to position 1 at least.

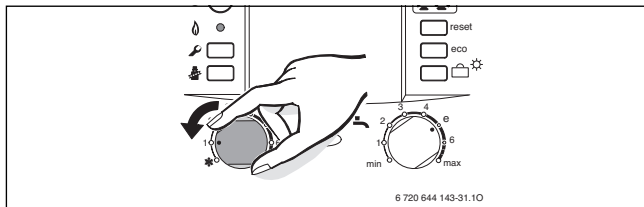

Fig. 13

- ▶ Add anti-freeze to the heating water (see installation instructions) and drain the DHW circuit.

Additional instructions are contained in the operating instructions for the heating programmer.

Frost protection for the cylinder:

- ▶ Turn DHW temperature controller clockwise as far as it will go (5 °C).

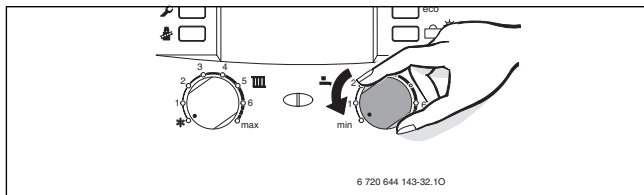



Fig. 14

4.9 Holiday mode

To switch on holiday mode:

- ▶ Press and hold holiday button  on the appliance until it lights up, and switch on holiday mode on the heating controller.
In holiday mode, heating and DHW heating are switched off; frost protection remains active (→ chap. 4.8).

To switch off holiday mode:

- ▶ Press and hold holiday button  on the appliance until it goes out, and cancel holiday mode on the heating controller.
The appliance returns to operation in standard mode according to the settings at the heating control unit.

4.10 Further displays







Display code	Description
	Fault code (→ chapter 7)
	Inspection due
	Pump anti-seize function active
	Trap filling function active
	Bleeding function active
	Excessively rapid increase in CH flow temperature (temp. gradient monitoring). Heating mode is disabled for two minutes.
	Drying function. If the floor drying function is activated on the weather-dependent controller, refer to controller instructions.

Table 6

5 Carry out thermal disinfection

To prevent the DHW becoming contaminated by bacteria such as legionella, we recommend you pasteurise the system after longer idle periods.



With some heating controllers, thermal disinfection can be programmed for a fixed time; see heating controller operating instructions.

Pasteurisation covers the DHW system including the draw-off points. For solar DHW cylinders, the solar portion of the cylinder is not covered.



DANGER: Risk of scalding!

Hot water can result in severe scalding.

- ▶ Carry out thermal disinfection only outside the normal hours of use.
- ▶ The water in the tank will take a while to cool down to the set hot water temperature as a result of heat loss. Be aware that, after thermal disinfection, the hot water may be hotter than the set temperature.

- ▶ Turn off all hot water points.
- ▶ Warn occupants of risk of scalding.
- ▶ If the heating programmer has a DHW program, set the time and DHW temperature accordingly.
- ▶ If there is a circulation pump, set it to run continuously.

- ▶ Turn hot water temperature control clockwise as far as the stop (approx. 70 °C).

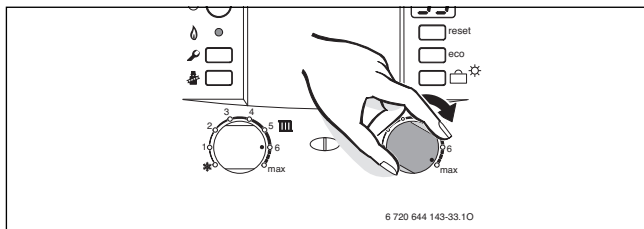

Fig. 15

- ▶ Wait until the water reaches the maximum temperature.
- ▶ Draw off water in turn from the nearest to the furthest hot water point until hot water has been running out at a temperature of 70 °C for 3 minutes.
- ▶ Reset DHW temperature control, circulation pump and heating programmer to their standard settings.



If you want to interrupt thermal disinfection:

- ▶ Switch the appliance off and then on again at the main switch. The appliance will start up again and the central heating flow temperature will be displayed.

6 Tips on saving energy

Heating economically

The boiler is designed to provide a high level of comfort while keeping gas consumption and the resulting environmental impact as low as possible. The gas supply to the burner is controlled according to the level of demand for heat. The boiler continues to operate with a low flame if the demand for heat reduces. The technical term for this process is modulating control. Modulating control keeps temperature fluctuations small and provides even distribution of heat throughout the home. This means that the boiler may stay on for relatively long periods but will use less gas than an appliance that continually switches on and off.

Inspection/Maintenance

To ensure that gas consumption and environmental impact (pollution, etc.) remain as low as possible over an extended period of time, we recommend that you take out an inspection/maintenance contract with an authorised installer covering the annual inspection and servicing and maintenance at other times as required.

Heating control system

Additional instructions are contained in the operating instructions for the heating controller.

Thermostat

Fully open the thermostat to ensure that the required room temperature is reached in all cases. Only after the required temperature has been reached and maintained for an extended period of time should you change the setting for the heating curve or the room temperature on the controller.

Underfloor heating

Do not set the heating-up temperature higher than the maximum level recommended by the manufacturer.

Ventilating

Do not keep windows slightly open for ventilation purposes. This would continuously cool down the room without significantly improving the air in the room. It is better to ventilate fully for a short time (with completely open windows).

Turn off the thermostat when ventilating.

Hot water

Always set the hot water temperature to as low as possible.

A lower setting on the thermostat means a higher rate of energy savings.

Furthermore, higher hot water temperatures result in increased limescale deposits and thereby impair the function of the appliance (e.g. longer heating-up times or lower output).

Circulation pump

If there is a circulation pump for hot water, use a timer programme to control its operation according to the specific requirements (e.g. morning, afternoon, evening).

7 Troubleshooting

All safety, modulation and control components are monitored by the Heatronic system.

If a fault occurs during operation, a warning tone sounds.



If you press a button, the warning tone stops.

The display indicates a fault (e. g. ) and the reset-button may also flash.

If the reset button flashes:

- ▶ Press and hold the reset button until the display shows .
The appliance will start up again and the flow temperature will be displayed.

If the reset button does not flash:

- ▶ Switch the appliance off and then on again at the main switch.
The appliance will start up again and the central heating flow temperature will be displayed.

If the fault persists:

- ▶ Contact your authorised contractor or customer service for assistance, providing details of the fault and the appliance.
-



An overview of the display indications can be found on page 31.

Appliance details

If you need to call Customer Services, it is helpful if you have the precise details of your appliance at hand.

Those details can be found on the identification plate or identification sticker inside the control panel cover.

Condens 5000 W (e. g. ZWB 37-2A...).....

Serial number.....

Date commissioned:

System installed by:

8 Maintenance

Inspection and maintenance

The operator is responsible for the safety and environmental compatibility of the heating system (see local regulations).

It is therefore recommended that you enter into a maintenance and inspection contract with an approved contractor that provides annual inspection and maintenance. This ensures high efficiency and environmentally compatible combustion.

Cleaning the outer casing

Wipe down with a damp cloth. Do not use any abrasive or corrosive cleaning agents.

9 Environment / disposal

Environmental protection is a fundamental corporate strategy of Bosch Group. The quality of our products, their economy and environmental safety are all of equal importance to us and all environmental protection legislation and regulations are strictly observed.

We use the best possible technology and materials for protecting the environment taking account of economic considerations.

Packaging

Where packaging is concerned, we participate in country-specific recycling processes that ensure optimum recycling.

All of our packaging materials are environmentally compatible and can be recycled.

Used appliances

Used appliances contain valuable materials that should be recycled.

The various assemblies can be easily dismantled and synthetic materials are marked accordingly. Assemblies can therefore be sorted by composition and passed on for recycling or disposal.

10 Operating instructions quick reference

Switching on

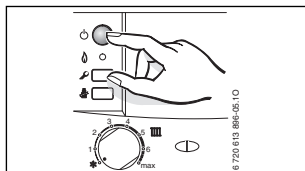

Switching on the central heating

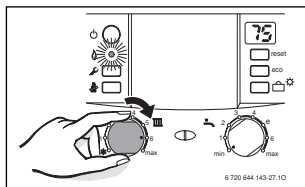

Heating control

Set weather-dependent heating controller to the relevant heating curve and operating mode or set room thermostat to the desired temperature.

Domestic hot water temperature



WARNING:

Risk of scalding

- ▶ Do not set the temperature control to more than "e".

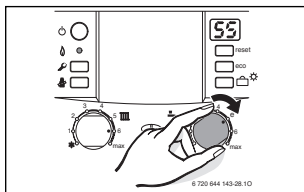

Eco button lit – Economy mode.

Eco button not lit – Comfort mode.

Frost protection

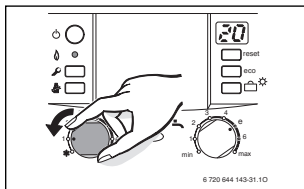

Robert Bosch (Australia) Pty Ltd
Thermotechnology Division
1555 Centre Road
Clayton Victoria 3168

Australia
Phone: 1300 30 70 37
Fax: 1300 30 70 38
www.bosch-climate.com.au

New Zealand
Phone: 0800 54 33 52
Fax: 0800 54 33 55
www.bosch-climate.co.nz