

## Template for Reporting Results of Biomarker Testing of Specimens From Patients With Carcinoma of the Colon and Rectum

---

Template web posting date: December 2014

### Authors

Angela N. Bartley, MD, FCAP

Department of Pathology, St. Joseph Mercy Hospital, Ann Arbor, MI

Stanley R. Hamilton, MD, FCAP

Division of Pathology and Laboratory Medicine, University of Texas MD Anderson Cancer Center,  
Houston, TX

Randa Alsabeh, MD, FCAP

Beverly Hills, CA

Edward P. Ambinder, MD

Department of Medicine (Medical Oncology and Hematology), Tisch Cancer Institute, Icahn  
School of Medicine at Mount Sinai, New York, NY

Michael Berman, MD, FCAP

Department of Pathology, Jefferson Regional Medical Center, Jefferson Hills, PA

Elaine Collins, MA, RHIA, CTR

St. Paul, MN

Patrick L. Fitzgibbons, MD, FCAP

Department of Pathology, St. Jude Medical Center, Fullerton, CA

Donna M. Gress, RHIT, CTR

American Joint Committee on Cancer (AJCC), Chicago, IL

Jan A. Nowak, PhD, MD, FCAP

Department of Pathology and Laboratory Medicine, NorthShore University HealthSystem,  
Evanston, IL

Wade S. Samowitz, MD

Department of Pathology, University of Utah, Salt Lake City, UT

Yousuf Zafar, MD, MHS

Department of Medicine, Division of Medical Oncology, Duke University Medical Center,  
Durham, NC

For the Members of the Cancer Biomarker Reporting Workgroup, College of American Pathologists

© 2014 College of American Pathologists (CAP). All rights reserved.

The College does not permit reproduction of any substantial portion of these templates without its written authorization. The College hereby authorizes use of these templates by physicians and other health care providers in reporting results of biomarker testing on patient specimens, in teaching, and in carrying out medical research for nonprofit purposes. This authorization does not extend to reproduction or other use of any substantial portion of these templates for commercial purposes without the written consent of the College.

The CAP also authorizes physicians and other health care practitioners to make modified versions of the templates solely for their individual use in reporting results of biomarker testing for individual patients, teaching, and carrying out medical research for non-profit purposes.

The CAP further authorizes the following uses by physicians and other health care practitioners, in reporting on surgical specimens for individual patients, in teaching, and in carrying out medical research for non-profit purposes: (1) **Dictation** from the original or modified templates for the purposes of creating a text-based patient record on paper, or in a word processing document; (2) **Copying** from the original or modified templates into a text-based patient record on paper, or in a word processing document; (3) The use of a **computerized system** for items (1) and (2), provided that the template data is stored intact as a single text-based document, and is not stored as multiple discrete data fields. Other than uses (1), (2), and (3) above, the CAP does not authorize any use of the templates in electronic medical records systems, pathology informatics systems, cancer registry computer systems, computerized databases, mappings between coding works, or any computerized system without a written license from the CAP.

Any public dissemination of the original or modified templates is prohibited without a written license from the CAP.

The College of American Pathologists offers these templates to assist pathologists in providing clinically useful and relevant information when reporting results of biomarker testing. The College regards the reporting elements in the templates as important elements of the biomarker test report, but the manner in which these elements are reported is at the discretion of each specific pathologist, taking into account clinician preferences, institutional policies, and individual practice.

The College developed these templates as educational tools to assist pathologists in the useful reporting of relevant information. It did not issue them for use in litigation, reimbursement, or other contexts. Nevertheless, the College recognizes that the templates might be used by hospitals, attorneys, payers, and others. The College cautions that use of the templates other than for their intended educational purpose may involve additional considerations that are beyond the scope of this document. The inclusion of a product name or service in a CAP publication should not be construed as an endorsement of such product or service, nor is failure to include the name of a product or service to be construed as disapproval.

## CAP Colon and Rectum Biomarker Template Revision History

---

### Version Code

The definition of the version code can be found at [www.cap.org/cancerprotocols](http://www.cap.org/cancerprotocols).

**Version:** ColonBiomarkers 1.2.0.0

### Summary of Changes

The following changes have been made since the October 2013 release.

### RESULTS

#### Microsatellite Instability

Format for percentage reporting was changed and reference was added for National Cancer Institute (NCI) markers.

#### Loci Testing

An option for "Not performed" was added.

#### KRAS Mutational Analysis

Reference to "wild type *KRAS* allele" was removed. "Mutation not stated" was revised to "mutation, not otherwise specified." Reporting option for "Gln61Leu (CAA>CCA)" was added.

#### NRAS Mutational Analysis

##### **BRAF Expression (by immunohistochemistry)**

Sections were added.

#### BRAF Mutational Analysis

Reference to "wild type *BRAF* allele" was removed. Formatting for reporting "**BRAF V600E (c.1799T>A) mutation**" and "Other BRAF mutation" was revised.

#### PIK3CA Mutational Analysis

Reference to "wild type *PIK3CA* allele" was removed.

#### PTEN Mutational Analysis

Reference to "wild type *PTEN* allele" was removed.

### METHODS

#### KRAS Mutational Analysis

Options for specifying applicable codons were removed.

#### NRAS Mutational Analysis

Section was added.

#### PTEN Expression and Mutational Analysis

Options added to specify IHC antibody and ISH probe used in testing.

## Biomarker Reporting Template

---

Template web posting date: December 2014

Completion of the template is the responsibility of the laboratory performing the biomarker testing and/or providing the interpretation. When both testing and interpretation are performed elsewhere (eg, a reference laboratory), synoptic reporting of the results by the laboratory submitting the tissue for testing is also encouraged to ensure that all information is included in the patient's medical record and thus readily available to the treating clinical team.

### COLON AND RECTUM

Select a single response unless otherwise indicated.

*Note: Use of this template is optional.*

#### + RESULTS

#### + Immunohistochemistry (IHC) Testing for Mismatch Repair (MMR) Proteins (select all that apply) (Note A)

- + \_\_\_ MLH1
  - + \_\_\_ Intact nuclear expression
  - + \_\_\_ Loss of nuclear expression
  - + \_\_\_ Cannot be determined (explain): \_\_\_\_\_
- + \_\_\_ MSH2
  - + \_\_\_ Intact nuclear expression
  - + \_\_\_ Loss of nuclear expression
  - + \_\_\_ Cannot be determined (explain): \_\_\_\_\_
- + \_\_\_ MSH6
  - + \_\_\_ Intact nuclear expression
  - + \_\_\_ Loss of nuclear expression
  - + \_\_\_ Cannot be determined (explain): \_\_\_\_\_
- + \_\_\_ PMS2
  - + \_\_\_ Intact nuclear expression
  - + \_\_\_ Loss of nuclear expression
  - + \_\_\_ Cannot be determined (explain): \_\_\_\_\_
- + \_\_\_ Background nonneoplastic tissue/internal control with intact nuclear expression

#### + IHC Interpretation

- + \_\_\_ No loss of nuclear expression of MMR proteins: low probability of microsatellite instability-high (MSI-H)<sup>#</sup>
- + \_\_\_ Loss of nuclear expression of MLH1 and PMS2: testing for methylation of the *MLH1* promoter and/or mutation of *BRAF* is indicated (the presence of a *BRAF* V600E mutation and/or *MLH1* methylation suggests that the tumor is sporadic and germline evaluation is probably not indicated; absence of both *MLH1* methylation and of *BRAF* V600E mutation suggests the possibility of Lynch syndrome, and sequencing and/or large deletion/duplication testing of germline *MLH1* may be indicated)<sup>#</sup>

+ Data elements preceded by this symbol are not required.

- + \_\_\_ Loss of nuclear expression of MSH2 and MSH6: high probability of Lynch syndrome (sequencing and/or large deletion/duplication testing of germline *MSH2* may be indicated, and, if negative, sequencing and/or large deletion/duplication testing of germline *MSH6* may be indicated)<sup>#</sup>
- + \_\_\_ Loss of nuclear expression of MSH6 only: high probability of Lynch syndrome (sequencing and/or large deletion/duplication testing of germline *MSH6* may be indicated)<sup>#</sup>
- + \_\_\_ Loss of nuclear expression of PMS2 only: high probability of Lynch syndrome (sequencing and/or large deletion/duplication testing of germline *PMS2* may be indicated)<sup>#</sup>

<sup>#</sup> There are exceptions to the above IHC interpretations. These results should not be considered in isolation, and clinical correlation with genetic counseling is recommended to assess the need for germline testing.

**+ Microsatellite Instability (MSI) (Note A)**

- + \_\_\_ MSI – stable (MSS)
- + \_\_\_ MSI – low (MSI-L)
  - + \_\_\_ 1% - 29% of the National Cancer Institute (NCI) or mononucleotide markers exhibit instability
  - + \_\_\_ 1 of the NCI or mononucleotide markers exhibit instability
  - + \_\_\_ Other (specify): \_\_\_\_\_
- + \_\_\_ MSI – high (MSI-H)
  - + \_\_\_ ≥30% of the NCI or mononucleotide markers exhibit instability
  - + \_\_\_ 2 or more of the NCI or mononucleotide markers exhibit instability
  - + \_\_\_ Other (specify): \_\_\_\_\_
- + \_\_\_ MSI – indeterminate

**+ Loci Testing**

- + \_\_\_ Mononucleotide panel
  - + BAT-25
    - + \_\_\_ Stable
    - + \_\_\_ Unstable
    - + \_\_\_ Cannot be determined (explain): \_\_\_\_\_
    - + \_\_\_ Not performed
  - + BAT-26
    - + \_\_\_ Stable
    - + \_\_\_ Unstable
    - + \_\_\_ Cannot be determined (explain): \_\_\_\_\_
    - + \_\_\_ Not performed
  - + NR-21
    - + \_\_\_ Stable
    - + \_\_\_ Unstable
    - + \_\_\_ Cannot be determined (explain): \_\_\_\_\_
    - + \_\_\_ Not performed
  - + NR-24
    - + \_\_\_ Stable
    - + \_\_\_ Unstable
    - + \_\_\_ Cannot be determined (explain): \_\_\_\_\_
    - + \_\_\_ Not performed
  - + Mono-27
    - + \_\_\_ Stable
    - + \_\_\_ Unstable
    - + \_\_\_ Cannot be determined (explain): \_\_\_\_\_
    - + \_\_\_ Not performed

+ Data elements preceded by this symbol are not required.

- + \_\_\_ NCI panel
  - + BAT-25
    - + \_\_\_ Stable
    - + \_\_\_ Unstable
    - + \_\_\_ Cannot be determined (explain): \_\_\_\_\_
    - + \_\_\_ Not performed
  - + BAT -26
    - + \_\_\_ Stable
    - + \_\_\_ Unstable
    - + \_\_\_ Cannot be determined (explain): \_\_\_\_\_
    - + \_\_\_ Not performed
  - + D2S123
    - + \_\_\_ Stable
    - + \_\_\_ Unstable
    - + \_\_\_ Cannot be determined (explain): \_\_\_\_\_
    - + \_\_\_ Not performed
  - + D5S346
    - + \_\_\_ Stable
    - + \_\_\_ Unstable
    - + \_\_\_ Cannot be determined (explain): \_\_\_\_\_
    - + \_\_\_ Not performed
  - + D17S250
    - + \_\_\_ Stable
    - + \_\_\_ Unstable
    - + \_\_\_ Cannot be determined (explain): \_\_\_\_\_
    - + \_\_\_ Not performed
- + \_\_\_ Other (specify): \_\_\_\_\_
  - + \_\_\_ Stable
  - + \_\_\_ Unstable
  - + \_\_\_ Cannot be determined (explain): \_\_\_\_\_

**+ MLH1 Promoter Methylation Analysis (Note B)**

- + \_\_\_ *MLH1* promoter hypermethylation present
- + \_\_\_ *MLH1* promoter hypermethylation absent
- + \_\_\_ Cannot be determined (explain): \_\_\_\_\_

**+ KRAS Mutational Analysis (Note C)**

- + \_\_\_ No mutation detected
- + \_\_\_ Mutation identified (select all that apply)
  - + Codon 12
    - + \_\_\_ Gly12Asp (GGT>GAT)
    - + \_\_\_ Gly12Val (GGT>GTT)
    - + \_\_\_ Gly12Cys (GGT>TGT)
    - + \_\_\_ Gly12Ser (GGT>AGT)
    - + \_\_\_ Gly12Ala (GGT>GCT)
    - + \_\_\_ Gly12 Arg (GGT>CGT)
    - + \_\_\_ Codon 12 mutation, not otherwise specified
    - + \_\_\_ Other codon 12 mutation (specify): \_\_\_\_\_
  - + Codon 13
    - + \_\_\_ Gly13Asp (GGC>GAC)
    - + \_\_\_ Gly13Arg (GGC>CGC)
    - + \_\_\_ Gly13Cys (GGC>TGC)

- +  Gly13Ala (GGC>GCC)
- +  Gly13Val (GGC>GTC)
- +  Codon 13 mutation, not otherwise specified
- +  Other codon 13 mutation (specify): \_\_\_\_\_
- + Codon 61
- +  Gln61Leu (CAA>CTA)
- +  Gln61His (CAA>CAC)
- +  Codon 61 mutation, not otherwise specified
- +  Other codon 61 mutation (specify): \_\_\_\_\_
- + Codon 146
- +  Ala146Thr (G436A) (GCA>ACA)
- +  Codon 146 mutation, not otherwise specified
- +  Other codon 146 mutation (specify): \_\_\_\_\_
- +  Other codon (specify): \_\_\_\_\_
- +  Cannot be determined (explain): \_\_\_\_\_

**+ NRAS Mutational Analysis (Note C)**

- +  No mutation detected
- +  Mutation identified (select all that apply)
  - + Codon 12
    - +  Gly12Asp (GGT>GAT)
    - +  Gly12Val (GGT>GTT)
    - +  Gly12Cys (GGT>TGT)
    - +  Gly12Ser (GGT>AGT)
    - +  Gly12Ala (GGT>GCT)
    - +  Gly12Arg (GGT>CGT)
    - +  Codon 12 mutation, not otherwise specified
    - +  Other codon 12 mutation (specify): \_\_\_\_\_
  - + Codon 13
    - +  Specific codon 13 mutation (specify): \_\_\_\_\_
    - +  Codon 13 mutation, not otherwise specified
  - + Codon 61
    - +  Gln61Lys (CAA>AAA)
    - +  Gln61Arg (CAA>CGA)
    - +  Codon 61 mutation, not otherwise specified
    - +  Other codon 61 mutation (specify): \_\_\_\_\_
    - +  Other codon (specify): \_\_\_\_\_
- +  Cannot be determined (explain): \_\_\_\_\_

**+ BRAF Expression (by immunohistochemistry) (Note B)**

- +  Positive cytoplasmic expression
- +  Negative for cytoplasmic expression
- +  Cannot be determined (explain): \_\_\_\_\_

**+ BRAF Mutational Analysis (Note B)**

- +  No mutations detected
- +  BRAF V600E (c.1799T>A) mutation
- +  Other BRAF mutation (specify): \_\_\_\_\_
- +  Cannot be determined (explain): \_\_\_\_\_

+ **PIK3CA Mutational Analysis (Note D)**

- + \_\_\_ No mutations detected
- + \_\_\_ Exon 9 mutation present (specify): \_\_\_\_\_
- + \_\_\_ Exon 20 mutation present (specify): \_\_\_\_\_
- + \_\_\_ Cannot be determined (explain): \_\_\_\_\_

+ **PTEN Expression (by immunohistochemistry) (Note E)**

- + \_\_\_ Positive cytoplasmic and/or nuclear expression
- + \_\_\_ Negative for cytoplasmic and nuclear expression
- + \_\_\_ Cannot be determined (explain): \_\_\_\_\_

+ **PTEN Mutational Analysis**

- + \_\_\_ No mutation detected
- + \_\_\_ Exon 1-9 mutation present (specify): \_\_\_\_\_
- + \_\_\_ Cannot be determined (explain): \_\_\_\_\_

+ **Multiparameter Gene Expression/Protein Expression Assay**

- + Specify type: \_\_\_\_\_
- + Results:
- + \_\_\_ Low risk
- + \_\_\_ Moderate risk
- + \_\_\_ High risk
- + Recurrence score: \_\_\_\_\_

+ **METHODS**

+ **Dissection Method(s) (select all that apply) (Note F)**

- + \_\_\_ Laser capture microdissection
  - + Specify test name#: \_\_\_\_\_
- + \_\_\_ Manual under microscopic observation
  - + Specify test name#: \_\_\_\_\_
- + \_\_\_ Manual without microscopic observation
  - + Specify test name#: \_\_\_\_\_
- + \_\_\_ Cored from block
  - + Specify test name#: \_\_\_\_\_
- + \_\_\_ Whole tissue section (no tumor enrichment procedure employed)
  - + Specify test name#: \_\_\_\_\_

*# If more than 1 dissection method used, please specify which test was associated with each selected dissection method.*

+ **Microsatellite Instability (MSI)**

- + Number of MSI markers tested (specify): \_\_\_\_\_

+ Cellularity

- + Percent tumor cells present in specimen: \_\_\_\_\_%

+ **Whole Genome or Exome Sequencing**

- + \_\_\_ Whole genome sequencing (specify): \_\_\_\_\_
- + \_\_\_ Whole exome sequencing (specify): \_\_\_\_\_



+ **MLH1 Promoter Methylation**

+ Testing Method

+ \_\_\_ Methylation-specific real-time polymerase chain reaction (PCR)

+ \_\_\_ Other (specify): \_\_\_\_\_

+ **KRAS Mutational Analysis**

+ Codons Assessed (select all that apply)

+ \_\_\_ 12

+ \_\_\_ 13

+ \_\_\_ 61

+ \_\_\_ 146

+ Testing Method(s) (select all that apply)

+ \_\_\_ Direct Sanger sequencing

+ \_\_\_ Pyrosequencing

+ \_\_\_ High-resolution melting analysis

+ \_\_\_ PCR, allele-specific hybridization

+ \_\_\_ Real-time PCR

+ \_\_\_ Other (specify): \_\_\_\_\_

# Please specify in Comments section if different testing methods are used for different codons.

+ **NRAS Mutational Analysis**

+ Codons Assessed (select all that apply)

+ \_\_\_ 12

+ \_\_\_ 13

+ \_\_\_ 61

+ Testing Method(s) (select all that apply)

+ \_\_\_ Direct Sanger sequencing

+ \_\_\_ Pyrosequencing

+ \_\_\_ High-resolution melting analysis

+ \_\_\_ PCR, allele-specific hybridization

+ \_\_\_ Real-time PCR

+ \_\_\_ Other (specify): \_\_\_\_\_

# Please specify in Comments section if different testing methods are used for different codons.

+ **BRAF Mutational Analysis**

+ Mutations Assessed (select all that apply)

+ \_\_\_ V600E

+ \_\_\_ Other BRAF V600 mutation (specify): \_\_\_\_\_

+ \_\_\_ Other (specify): \_\_\_\_\_

- + Testing Method (select all that apply)
- + \_\_\_ Direct Sanger sequencing
- + \_\_\_ PCR, allele-specific hybridization
- + \_\_\_ Pyrosequencing
- + \_\_\_ Real-time PCR
- + \_\_\_ Immunohistochemistry for V600E gene product
- + \_\_\_ Other (specify): \_\_\_\_\_

+ **PIK3CA Mutational Analysis**

- + Testing Method
- + \_\_\_ Direct Sanger sequencing
- + \_\_\_ Other (specify): \_\_\_\_\_

+ **PTEN Expression and Mutational Analysis**

- + Testing Method (select all that apply)
- + \_\_\_ Immunohistochemistry (specify antibody): \_\_\_\_\_
- + \_\_\_ In situ hybridization (specify probe): \_\_\_\_\_
- + \_\_\_ Direct Sanger sequencing
- + \_\_\_ Duplication/deletion testing (MLPA)
- + \_\_\_ Other (specify): \_\_\_\_\_

+ **COMMENT(S)**

\_\_\_\_\_

*Note: Fixative type, time to fixation (cold ischemia time), and time of fixation should be reported if applicable in this template or in the original pathology report.*

*Gene names should follow recommendations of The Human Genome Organisation (HUGO) Nomenclature Committee ([www.genenames.org](http://www.genenames.org); accessed February 10, 2015).*

*All reported gene sequence variations should be identified following the recommendations of the Human Genome Variation Society ([www.hgvs.org/mutnomen/](http://www.hgvs.org/mutnomen/); accessed February 10, 2015).*

## Explanatory Notes

---

### A. Mismatch Repair Testing: Microsatellite instability and Immunohistochemistry

Detection of defective mismatch repair in colorectal carcinomas is important for detection of Lynch syndrome (hereditary nonpolyposis colorectal cancer syndrome [HNPCC]), which accounts for approximately 2% to 3% of all colorectal carcinomas and has clinical implications for treatment of the affected patient and family members. Microsatellite instability (MSI) testing can be used to cost-effectively screen colorectal cancer patients for possible Lynch syndrome. Patients with a microsatellite instability-high (MSI-H) phenotype that indicates mismatch repair deficiency in their cancer may have a germline mutation in one of several DNA mismatch repair (MMR) genes (eg, *MLH1*, *MSH2*, *MSH6*, or *PMS2*) or an altered *EPCAM* (*TACSTD1*) gene. After appropriate genetic counseling, patients may want to consider testing to identify the causative heritable abnormality. An MSI-H phenotype is more frequently observed in sporadic colorectal cancer (about 15% of cases) due to somatic abnormalities, usually hypermethylation of the *MLH1* gene promoter. The specificity of MSI testing can be increased by using it primarily on at-risk populations, such as colorectal cancer patients younger than 50 years, or patients with a strong family history of Lynch-associated tumors (eg, colorectal, endometrial, gastric, or upper urinary tract urothelial carcinoma),<sup>1</sup> but with sacrifice of sensitivity, since a sizeable minority of cases lacks these clinical characteristics.

MSI testing of tumor DNA is generally performed with at least 5 microsatellite markers, generally mononucleotide or dinucleotide repeat markers. In 1998, a National Institutes of Health consensus panel proposed that laboratories use a 5-marker panel consisting of 3 dinucleotide and 2 mononucleotide repeats for MSI testing.<sup>2</sup> Recent data suggests that dinucleotide repeats may have lower sensitivity and specificity for identifying tumors with an MSI-H phenotype. As a consequence, there has been a move towards including more mononucleotides and fewer dinucleotides in MSI testing panels. Many laboratories now use a commercially available kit for MSI testing that utilizes 5 mononucleotide markers.

MSI testing is frequently done in conjunction with immunohistochemical (IHC) testing for DNA MMR protein expression (ie, *MLH1*, *MSH2*, *MSH6*, and *PMS2* expression). If DNA MMR IHC has not been performed, this testing should be recommended for any case that shows an MSI-H phenotype, because this information will help identify the gene that is most likely to have a germline mutation (eg, a patient whose tumor shows loss of *MSH2* and *MSH6* expression, but retention of *MLH1* and *PMS2* expression, is likely to have an *MSH2* germline mutation). If the results of DNA MMR IHC and MSI testing are discordant (eg, MSI-H phenotype with normal IHC or abnormal IHC with MSS phenotype), then the laboratory should make sure that the same sample was used for MSI and IHC testing and that there was no sample mix-up. However, MSI-H may not occur in colorectal cancers of patients with germline *MSH6* mutation. Intact expression of all 4 proteins indicates that MMR enzymes tested are intact but does not entirely exclude Lynch syndrome, as approximately 5% of families may have a missense mutation (especially in *MLH1*) that can lead to a nonfunctional protein with retained antigenicity. Defects in lesser-known MMR enzymes may also lead to a similar result, but this situation is rare.

Any positive reaction in the nuclei of tumor cells is considered as intact expression (normal), and it is common for intact staining to be somewhat patchy. An interpretation of expression loss in tumor cells should be made only if a positive reaction is seen in internal control cells, such as the nuclei of stromal, inflammatory, or nonneoplastic epithelial cells. Loss of expression of *MLH1* may be due to Lynch syndrome or methylation of the *MLH1* promoter region (as occurs in sporadic MSI colorectal carcinoma). Genetic testing is ultimately required for this distinction, although a specific *BRAF* gene mutation (V600E) is present in many sporadic cases, but not familial cancers. Loss of *MSH2* expression strongly suggests Lynch syndrome. *PMS2* loss is often associated with loss of *MLH1* and is only independently meaningful if *MLH1* is intact. *MSH6* is similarly related to *MSH2*. One should also keep in mind that nucleolar staining or complete loss of *MSH6* staining has been described in colorectal cancer

cases with prior radiation or chemotherapy,<sup>3,4</sup> and a significant reduction of MSH6 staining has been described in a small percentage of colorectal carcinomas with somatic mutations of the coding region microsatellites of the *MSH6* gene in MLH1/PMS2-deficient carcinomas.<sup>5</sup>

### B. *MLH1* Promoter Hypermethylation Analysis and *BRAF* Mutational Analysis

Defective mismatch repair in sporadic colorectal cancer is most often due to inactivation of the *MLH1* gene promoter by hypermethylation (epigenetic silencing). The V600E mutation of the *BRAF* gene may be present in up to 70% of tumors with hypermethylation of the *MLH1* promoter. In colorectal cancer, this mutation has been associated with a limited clinical response to epidermal growth factor receptor (*EGFR*) targeted therapies (cetuximab or panitumumab). Analysis for somatic mutations in the V600E hot spot in *BRAF* may also be indicated for tumors that show MSI-H, as this mutation has been found in sporadic MSI-H tumors, but not in Lynch-associated cancers with *MLH1* or *MSH2* mutations.<sup>6</sup> *BRAF* V600E mutations have been described in probands with monoallelic *PMS2* mutations.<sup>7</sup> Direct testing of *MLH1* promoter hypermethylation and/or the use of *BRAF* V600E mutational analysis prior to germline genetic testing in patients with MSI-H tumors and loss of MLH1 by IHC may be a cost-effective means of identifying patients with sporadic tumors for whom further testing is not indicated.<sup>8</sup>

### C. *RAS* Mutational Analysis

The presence of a *KRAS* mutation has been shown to be associated with lack of clinical response to therapies targeted at *EGFR*, such as cetuximab<sup>9</sup> and panitumumab.<sup>10</sup> While clinical guidelines for *KRAS* mutational analysis are evolving, current provisional recommendations from the American Society of Clinical Oncology are that all patients with stage IV colorectal carcinoma who are candidates for anti-*EGFR* antibody therapy should have their tumor tested for *KRAS* mutations.<sup>11</sup> Anti-*EGFR* antibody therapy is not recommended for patients whose tumors show mutations in *KRAS* codon 12, 13, or 61, but data on codon 146 are currently insufficient. A recent study has shown that *NRAS* mutation, like *KRAS* mutation, has influence on response to anti-*EGFR* therapy.<sup>12</sup> Although more studies are needed, these findings may lead to broad *KRAS* and *NRAS* panels to include codons 12, 13, 61, and 146 of both genes.

### D. *PIK3CA* Mutational Analysis

*PIK3CA* mutations activate the *PI3K-PTEN-AKT* pathway that is downstream from both the *EGFR* and the *RAS-RAF-MAPK* pathways. *PIK3CA* mutation and subsequent activation of the *AKT* pathway has been shown to play an important role in colorectal carcinogenesis and have been associated with *KRAS* mutation<sup>13</sup> and microsatellite instability.<sup>14</sup> *PIK3CA* mutation has further been associated with poor survival in resectable stage I to III colon cancer, with the adverse effect of *PIK3CA* mutation potentially limited to patients with *KRAS* wild-type tumors.<sup>15</sup> *PIK3CA* mutations have been associated with resistance to anti-*EGFR* therapy in several studies,<sup>16,17</sup> but not in others.<sup>18</sup> The reasons for the discrepancy are not clear. Mutations of exons 1, 9, and 20 of the *PIK3CA* gene represent >95% of known mutations.

A European consortium recently suggested that only *PIK3CA* exon 20 mutations are associated with a lack of cetuximab activity in *KRAS* wild-type tumors and with a shorter median progression-free survival and overall survival.<sup>17</sup> By contrast, exon 9 *PIK3CA* mutations are associated with *KRAS* mutations and do not have an independent effect on cetuximab efficacy.<sup>17</sup> More studies are needed to establish the prognostic and predictive roles of *PIK3CA* exon-9 and exon-20 mutations.

### E. *PTEN* Mutational Analysis

The role of *PTEN* loss in colorectal cancer prognosis and therapy is unclear. It has been suggested that loss of *PTEN* expression, as determined by immunohistochemistry, is associated with lack of benefit from cetuximab in metastatic colorectal cancer.<sup>19-22</sup> Loss of *PTEN* has been found to co-occur with *KRAS*, *BRAF*, and *PIK3CA* mutations.<sup>19,22</sup> The recorded frequency of loss of *PTEN* expression varies from 19% to 36%, with some studies reporting an effect on response rate and survival, whereas others found an effect only on progression-free or overall survival. Moreover, data on the loss of *PTEN* expression are not

concordant in primary and metastatic tissues.<sup>21</sup> There is currently no standardized method for PTEN expression analysis by immunohistochemistry.

#### F. Dissection Method

**Please denote the manner in which the tissue was dissected and specify the biomarker test only if different dissection methods are used for different tests.**

1. Laser capture microdissection (LCM): Use of a laser-equipped microscope to isolate and retrieve specific cells of interest from a histopathologic region of interest.
2. Manual under microscopic observation: hematoxylin and eosin (H&E) slide is examined under a light microscope and marked by a pathologist for subsequent tumor dissection and retrieval.
3. Manual without microscopic observation: H&E slide is examined without a microscope and marked by a pathologist for subsequent tumor dissection and retrieval.
4. Cored from block: Area of interest is cored from a paraffin-embedded tissue block.
5. Whole tissue section: No tumor enrichment procedure employed for tissue retrieval.

#### References

1. Umar A, Boland CR, Terdiman JP, et al. Revised Bethesda guidelines for hereditary nonpolyposis colorectal cancer (Lynch syndrome) and microsatellite instability. *J Natl Cancer Inst.* 2004;96(4):261-268.
2. Boland CR, Thibodeau SN, Hamilton SR, et al. A National Cancer Institute Workshop on Microsatellite Instability for cancer detection and familial predisposition: development of international criteria for the determination of microsatellite instability in colorectal cancer. *Cancer Res.* 1998;58(22):5248-5257.
3. Bellizzi AM, Crowder CD, Marsh WL, Hampel H, Frankel WL. Mismatch repair status in a cohort of rectal adenocarcinomas before and after chemoradiation. *Mod Pathol.* 2010;23:137A.
4. Radu OM, Nikiforova MN, Farkas LM, Krasinskas AM. Challenging cases encountered in colorectal cancer screening for Lynch syndrome reveal novel findings: nucleolar MSH6 staining and impact of prior chemoradiation therapy. *Hum Pathol.* 2011;42(9):1247-1258.
5. Shia J, Zhang L, Shike M, et al. Secondary mutation in a coding mononucleotide tract in MSH6 causes loss of immunoreexpression of MSH6 in colorectal carcinomas with MLH1/PMS2 deficiency. *Mod Pathol.* 2013;26(1):131-138.
6. Domingo E, Niessen RC, Oliveira C, et al. BRAF-V600E is not involved in the colorectal tumorigenesis of HNPCC in patients with functional MLH1 and MSH2 genes. *Oncogene.* 2005;24(24):3995-3998.
7. Senter, L, Clendenning, M, Sotamaa, K, et al. The clinical phenotype of Lynch syndrome due to germline PMS2 mutations. *Gastroenterology.* 2008;135(2):419-428.
8. Bessa X, Balleste B, Andreu M, et al. A prospective, multicenter, population-based study of BRAF mutational analysis for Lynch syndrome screening. *Clin Gastroenterol Hepatol.* 2008;6(2):206-214.
9. Lievre A, Bachet J-B, Le Corre D, et al. KRAS mutation status is predictive of response to cetuximab therapy in colorectal cancer. *Cancer Res.* 2006;66(8):3992-3995.
10. Amado RG, Wolf M, Peeters M, et al. Wild-type KRAS is required for panitumumab efficacy in patients with metastatic colorectal cancer. *J Clin Oncol.* 2008;26(10):1626-1634.
11. Allegra CJ, Jessup JM, Somerfield MR, et al. American Society of Clinical Oncology Provisional Clinical Opinion: testing for KRAS gene mutations in patients with metastatic colorectal carcinoma to predict response to anti-epidermal growth factor receptor monoclonal antibody therapy. *J Clin Oncol.* 2009;27(12):2091-2096.
12. Douillard JY, Oliner K, Siena S, et al. Panitumumab-FOLFOX4 treatment and RAS mutations in colorectal cancer. *N Engl J Med.* 2013;369(11):1023-1034.
13. Nosho K, Kawasaki T, Ohnishi M, et al. PIK3CA mutation in colorectal cancer: relationship with genetic and epigenetic alterations. *Neoplasia.* 2008;10(6):534-541.
14. Abubaker J, Bavi P, Al-Harbi S, et al. Clinicopathological analysis of colorectal cancers with PIK3CA mutations in Middle Eastern population. *Oncogene.* 2008;27(25):3539-3545.

15. Ogino S, Nosho K, Kirkner GJ, et al. PIK3CA mutation is associated with poor prognosis among patients with curatively resected colon cancer. *J Clin Oncol.* 2009;27(9):1477-1484.
16. De Roock, Claes B, Bernasconi D, et al. Effects of KRAS, BRAF, NRAS, and PIK3CA mutations on the efficacy of cetuximab plus chemotherapy in chemotherapy-refractory metastatic colorectal cancer: a retrospective consortium analysis. *Lancet Oncol.* 2010;11(8):753-762.
17. De Roock, De Vriendt V, Normanno N, Ciardiello F, Tejpar S. KRAS, BRAF, PIK3CA, and PTEN mutations: implications for targeted therapies in metastatic colorectal cancer. *Lancet Oncol.* 2011;12(6):594-603.
18. Prenen H, De Schutter J, Jacobs B, et al. PIK3CA mutations are not a major determinant of resistance to the epidermal growth factor receptor inhibitor cetuximab in metastatic colorectal cancer. *Clin Cancer Res.* 2009;15(9):3184-3188.
19. Laurent-Puig P, Cayre A, Manceau G, et al. Analysis of PTEN, BRAF, and EGFR status in determining benefit from cetuximab therapy in wild-type KRAS metastatic colon cancer. *J Clin Oncol.* 2009;27(35):5924-5930.
20. Frattini M, Saletti P, Romagnani E, et al. PTEN loss of expression predicts cetuximab efficacy in metastatic colorectal cancer patients. *Br J Cancer.* 2007;97(8):1139-1145.
21. Loupakis F, Pollina L, Stasi I, et al. PTEN expression and KRAS mutations on primary tumors and metastases in the prediction of benefit from cetuximab plus irinotecan for patients with metastatic colorectal cancer. *J Clin Oncol.* 2009; 27(16):2622-2629.
22. Sartore-Bianchi A, Di Nicolantonio F, Nichelatti M, et al. Multi-determinants analysis of molecular alterations for predicting clinical benefit to EGFR-targeted monoclonal antibodies in colorectal cancer. *PLoS One.* 2009;4(10):e7287.

**This ends the CAP cancer protocols. Following pages represents suggested LOINC and SNOMED CT value sets for use with protocols.**

<b>MLH1 Analysis</b>	<b>81691-8 - DNA mismatch repair protein Mlh1 [Presence] in Cancer by Immune stain</b>	
	Intact nuclear expression	2090001000004107   Intact genetic nucleoprotein expression (finding)
	Loss of nuclear expression	1810001000004106   Loss of genetic nucleoprotein expression (finding)
	Indeterminate	82334004   Indeterminate (qualifier value)

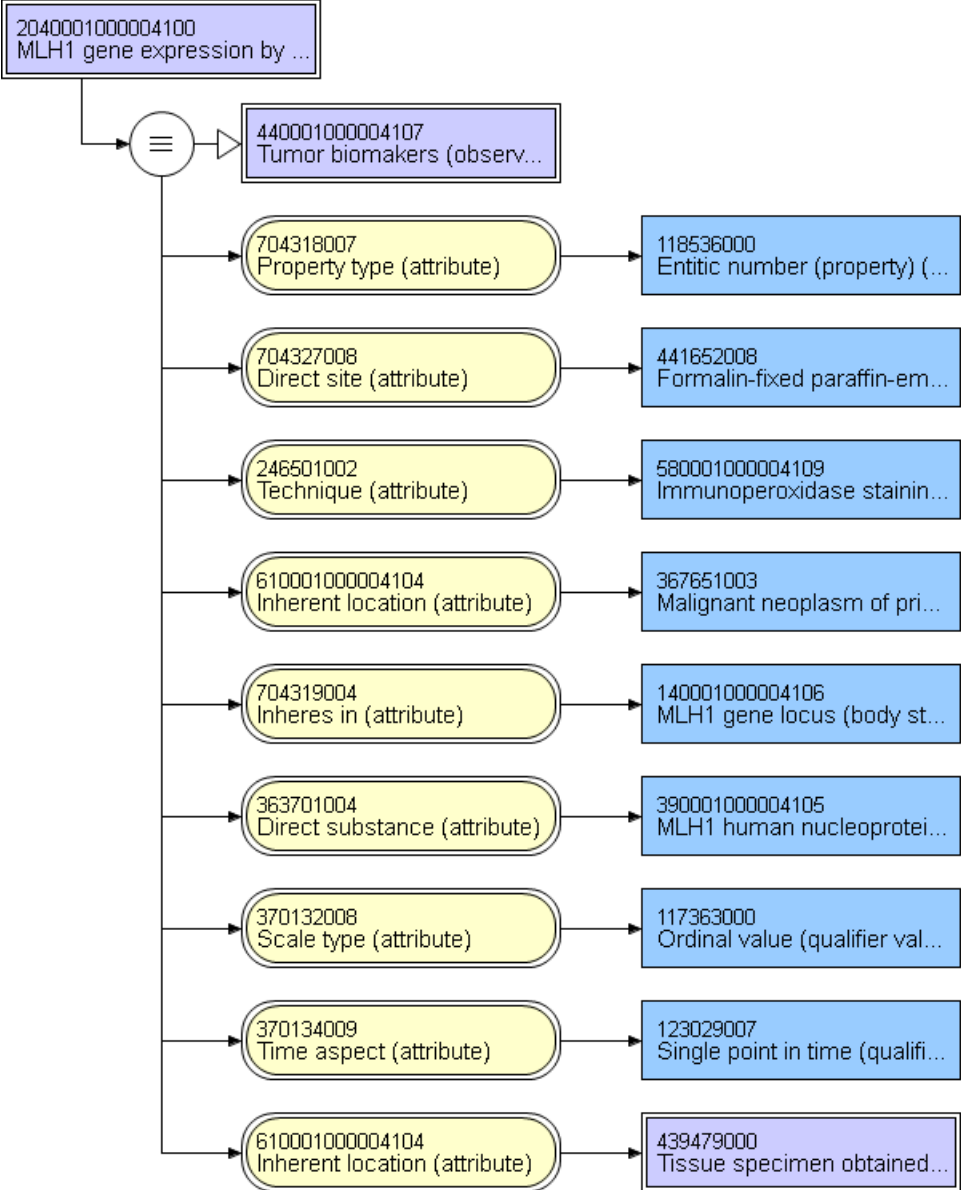

<b>MSH2 Analysis</b>	<b>81692-6 - DNA mismatch repair protein Msh2 [Presence] in Cancer by Immune stain</b>	
	Intact nuclear expression	2090001000004107   Intact genetic nucleoprotein expression (finding)
	Loss of nuclear expression	1810001000004106   Loss of genetic nucleoprotein expression (finding)
	Indeterminate	82334004   Indeterminate (qualifier value)

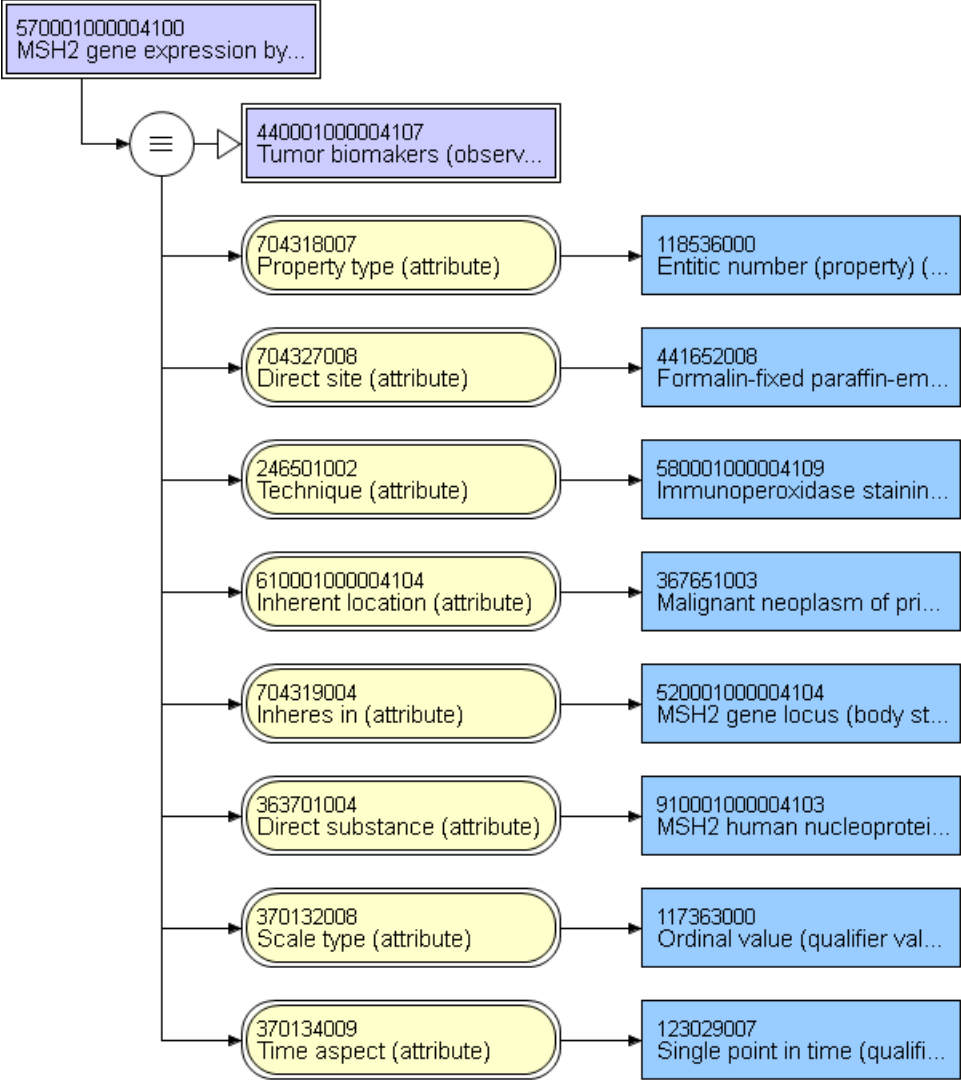



<b>MSH6 Analysis</b>	<b>81693-4 - DNA mismatch repair protein Msh6 [Presence] in Cancer by Immune stain</b>	
	Intact nuclear expression	2090001000004107   Intact genetic nucleoprotein expression (finding)
	Loss of nuclear expression	1810001000004106   Loss of genetic nucleoprotein expression (finding)
	Indeterminate	82334004   Indeterminate (qualifier value)

960001000004104  
MSH6 gene expression by...

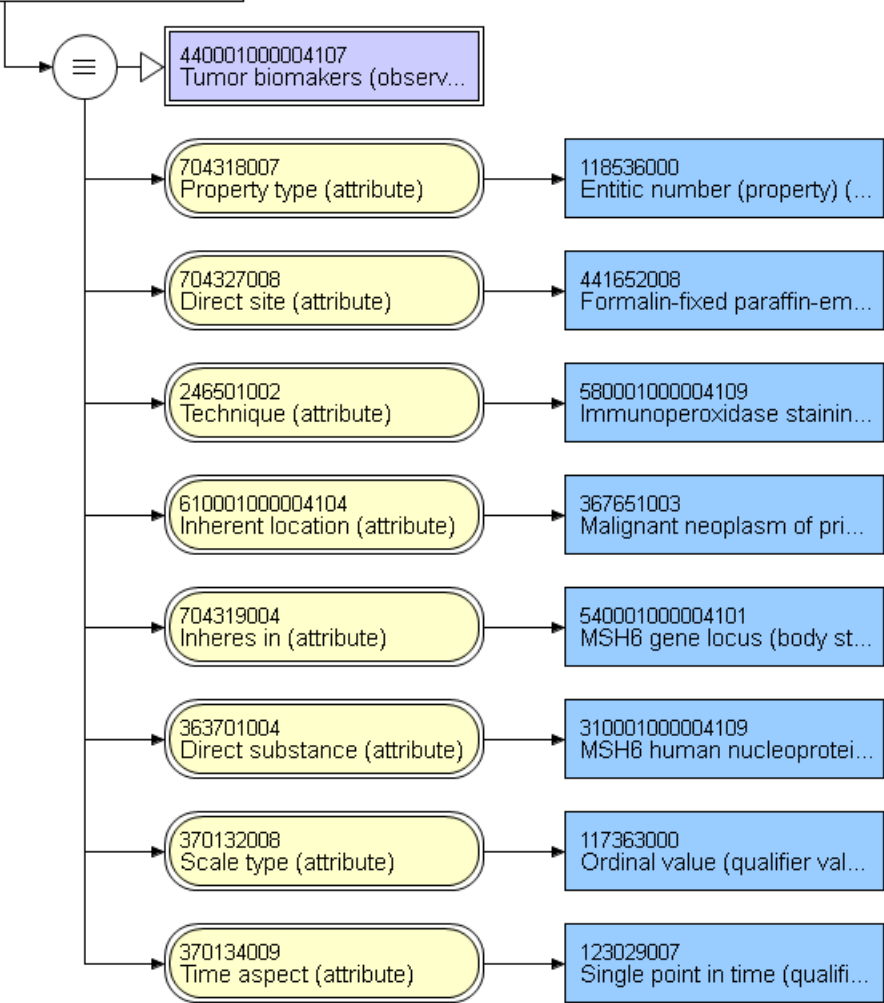

<b>PMS2 Analysis</b>	<b>81694-2 - Mismatch repair endonuclease PMS2 [Presence] in Cancer by Immune stain</b>	
	Intact nuclear expression	2090001000004107   Intact genetic nucleoprotein expression (finding)
	Loss of nuclear expression	1810001000004106   Loss of genetic nucleoprotein expression (finding)
	Indeterminate	82334004   Indeterminate (qualifier value)

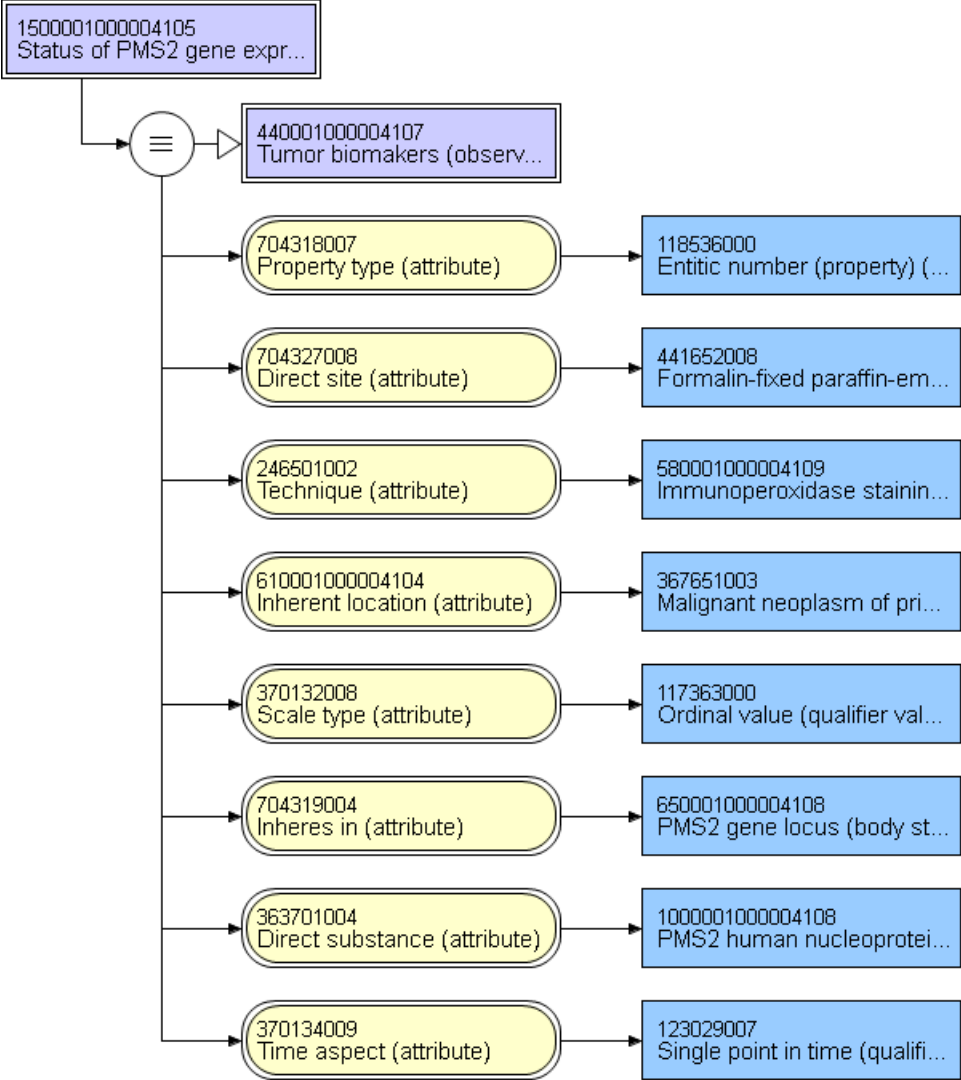

<b>Microsatellite instability</b>	<b>81695-9 - Microsatellite instability [Interpretation] in Cancer Qualitative</b>	
	Stable (MSS)	58158008   Stable (qualifier value)
	Low (MSI-L)	62482003   Low (qualifier value)
	High (MSI-H)	75540009   High (qualifier value)
	Indeterminate	82334004   Indeterminate (qualifier value)

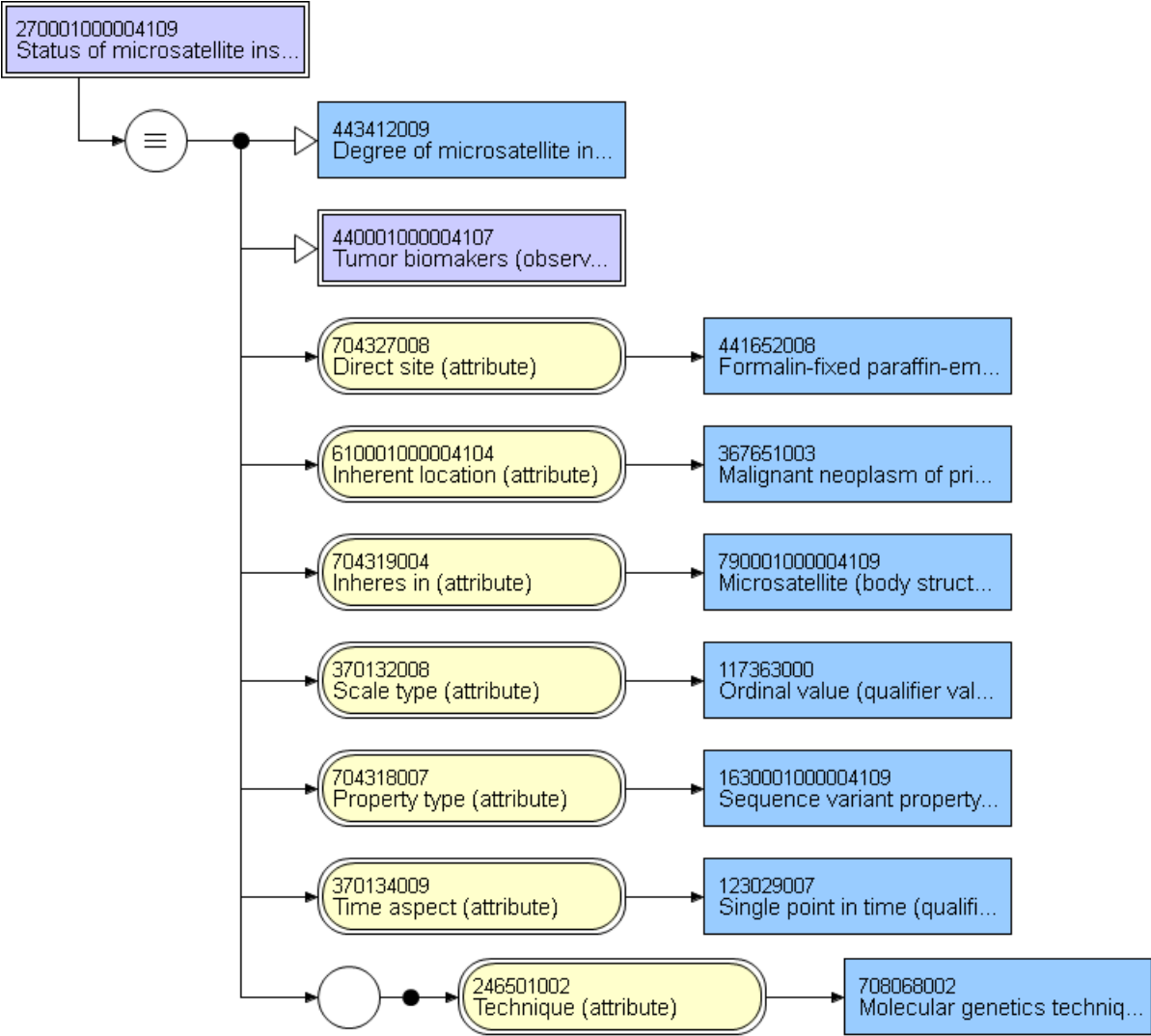

<b>Number of microsatellite markers assessed</b>	<b>81696-7 - Microsatellite instability markers assessed [#] in Cancer</b>	

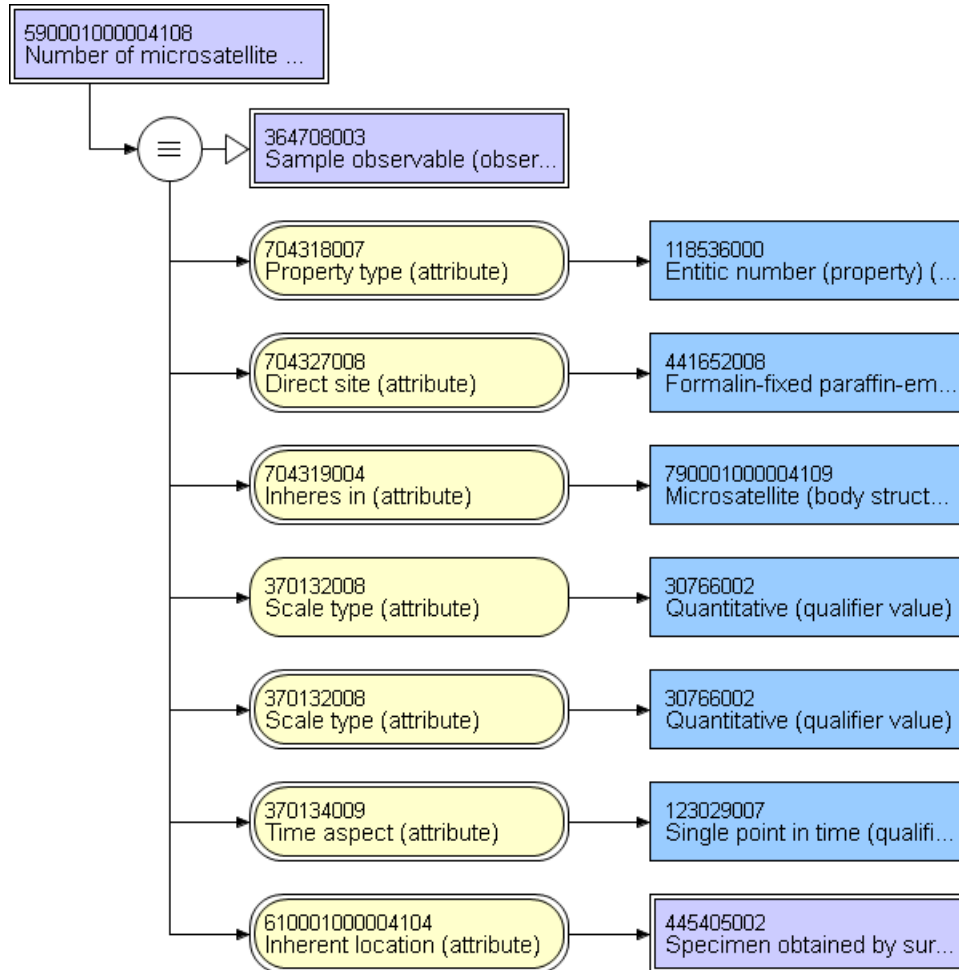

Percent microsatellite markers exhibiting instability	81708-0 - Microsatellite markers exhibiting instability/Microsatellite instability markers assessed in Cancer	
	_____ %	

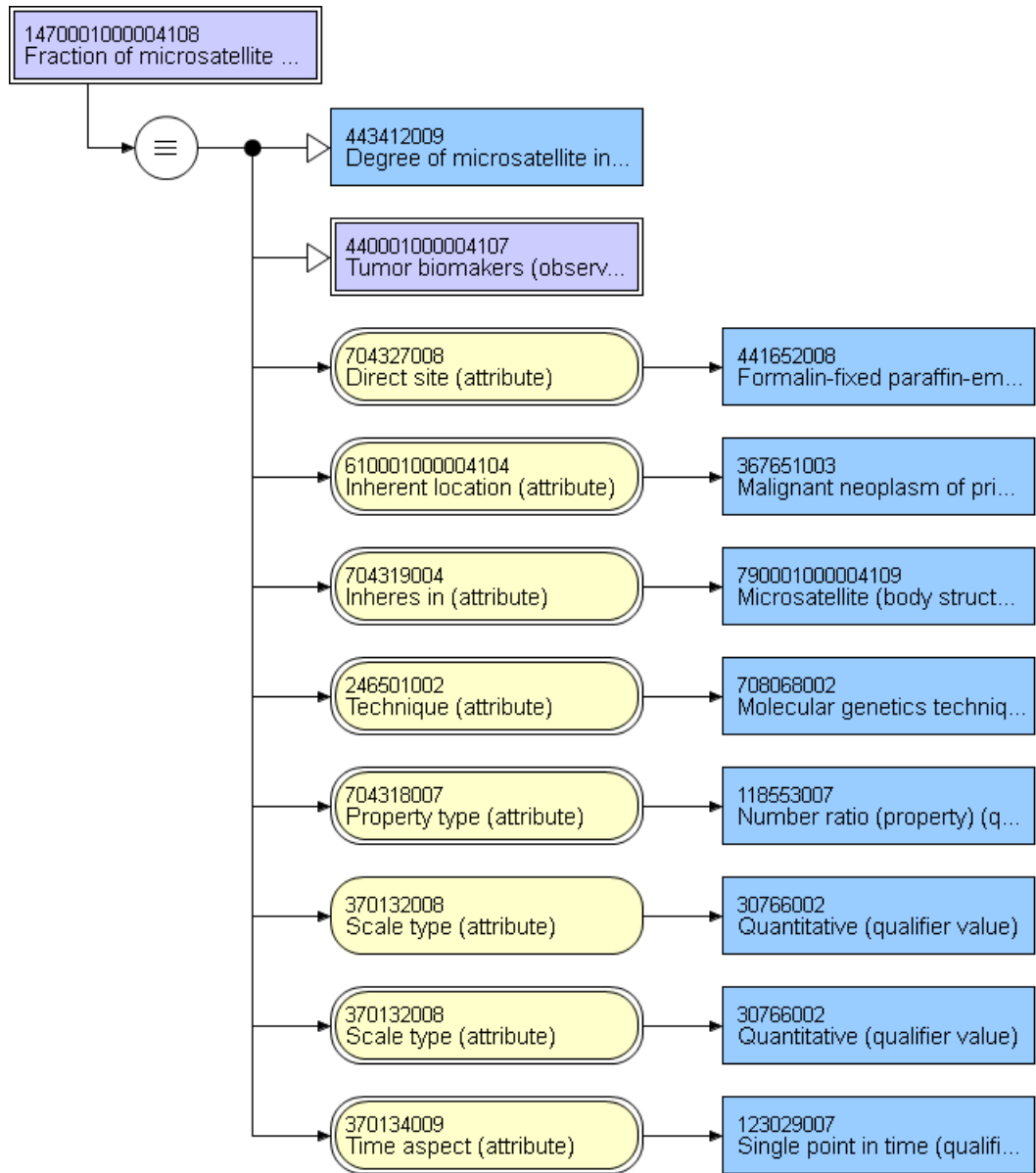

Number of microsatellite markers exhibiting instability	81709-8 - Microsatellite markers exhibiting instability [#] in Cancer

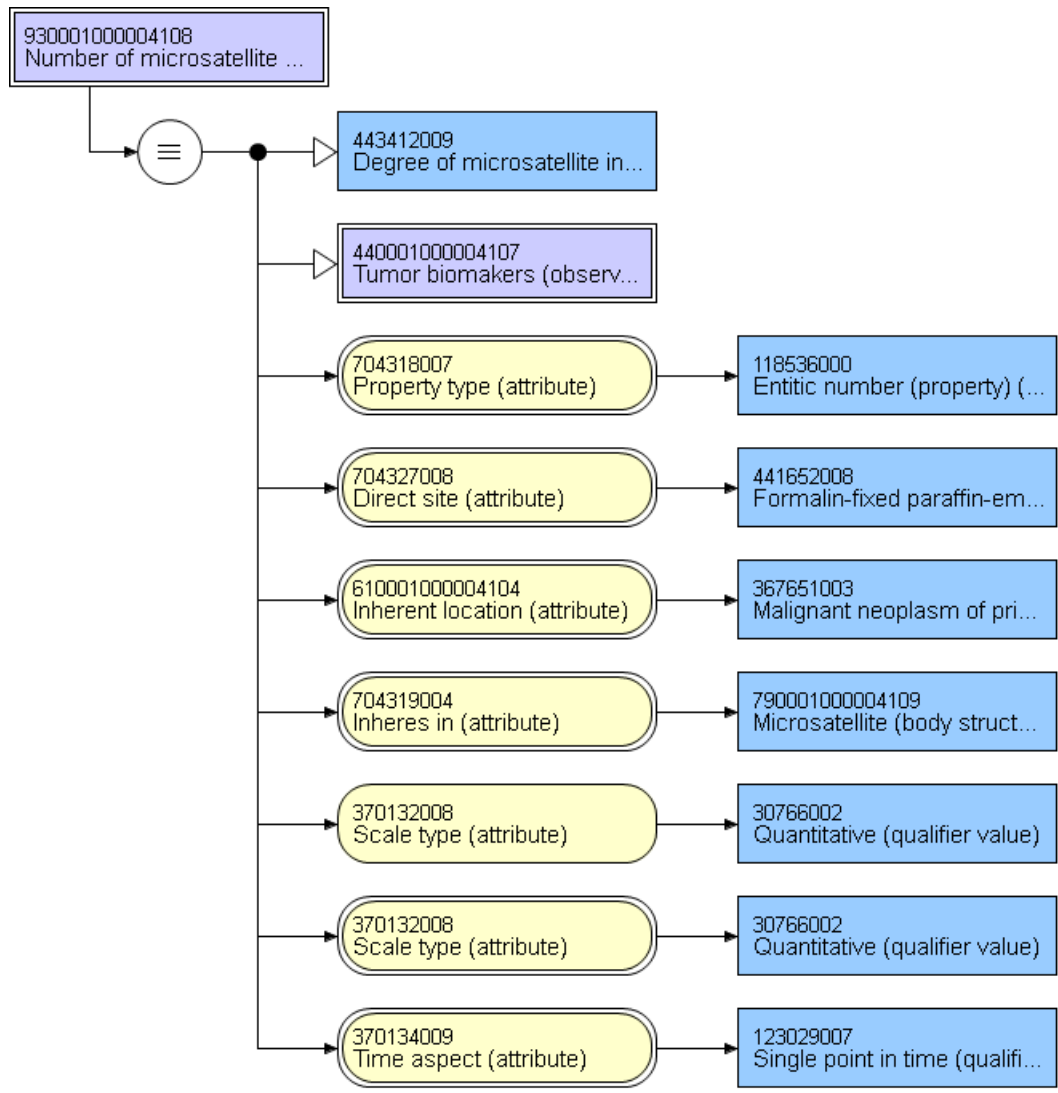

BAT-25 Loci stability	81697-5 - Microsatellite instability marker BAT25 in Cancer Qualitative	
	Stable	58158008   Stable (qualifier value)
	Unstable	263922001   Unstable status (qualifier value)
	Undetermined (explain): _____	373068000   Undetermined (qualifier value)

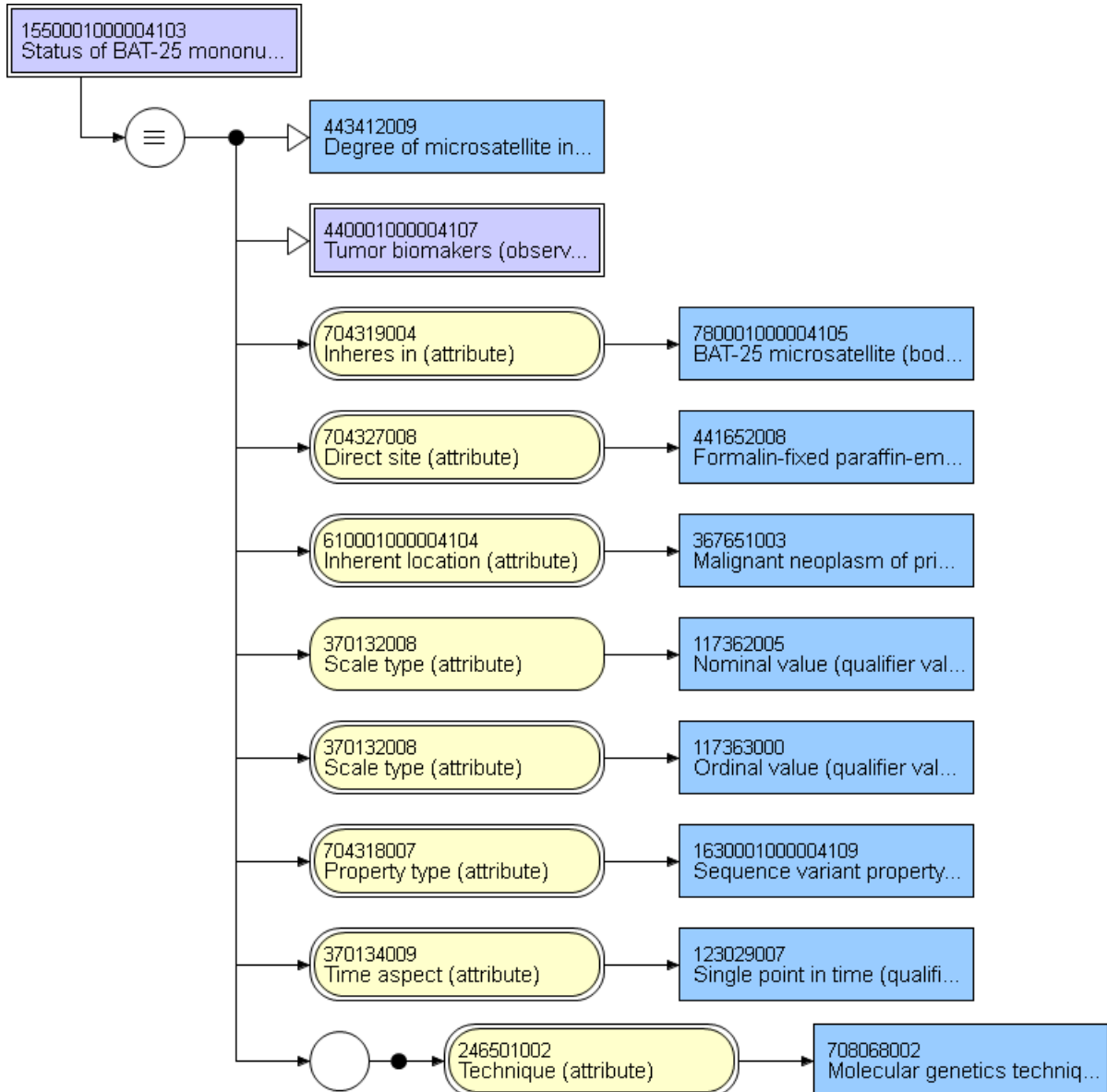

<b>BAT-26 Loci stability</b>	<b>81698-3 - Microsatellite instability marker BAT26 in Cancer Qualitative</b>
	Stable   58158008   Stable (qualifier value)
	Unstable   263922001   Unstable status (qualifier value)
	Undetermined (explain): _____   373068000   Undetermined (qualifier value)

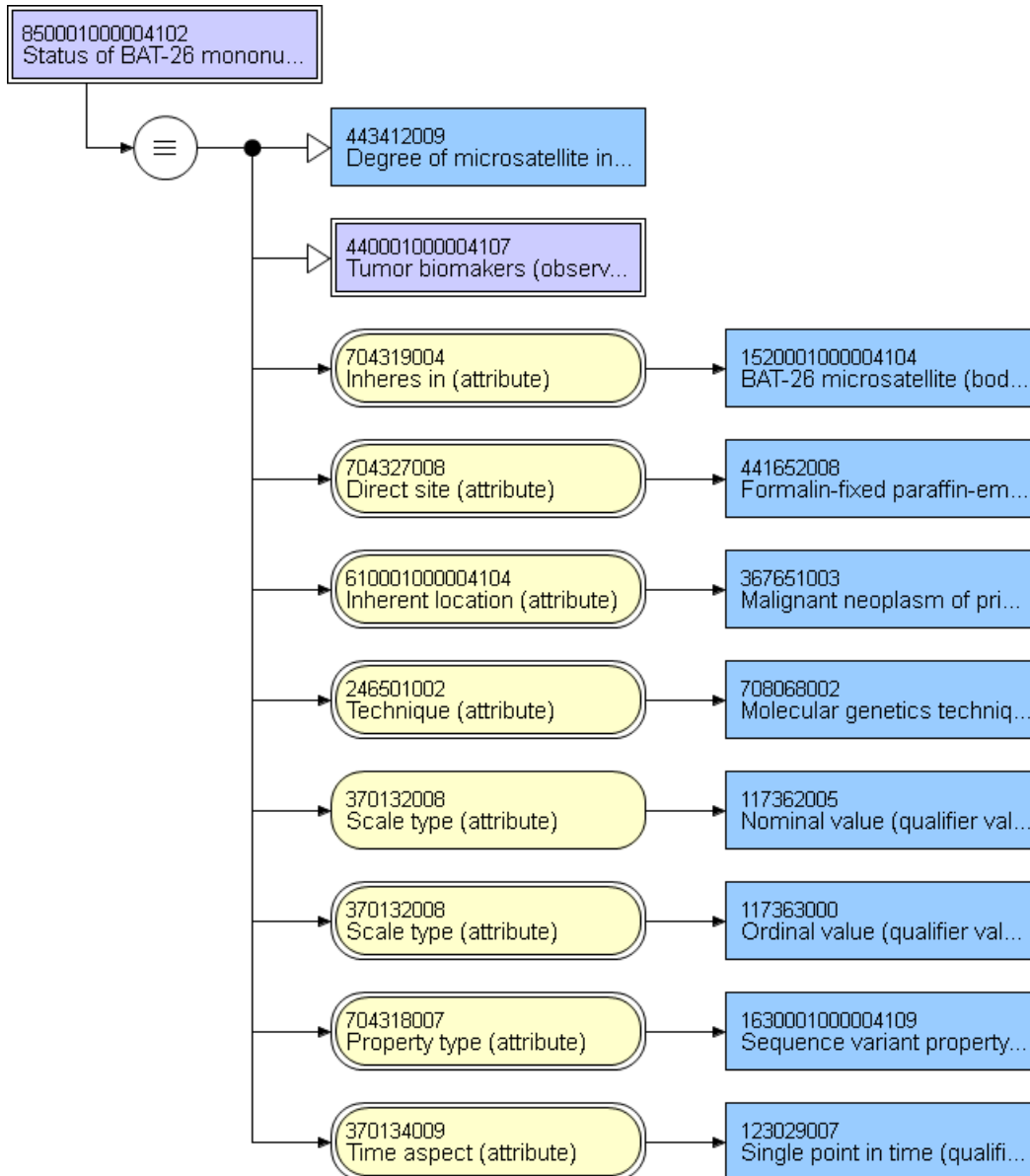



NR-21 Loci stability	81699-1 - Microsatellite instability marker NR21 in Cancer Qualitative	
	Stable	58158008   Stable (qualifier value)
	Unstable	263922001   Unstable status (qualifier value)
	Undetermined (explain): _____	373068000   Undetermined (qualifier value)

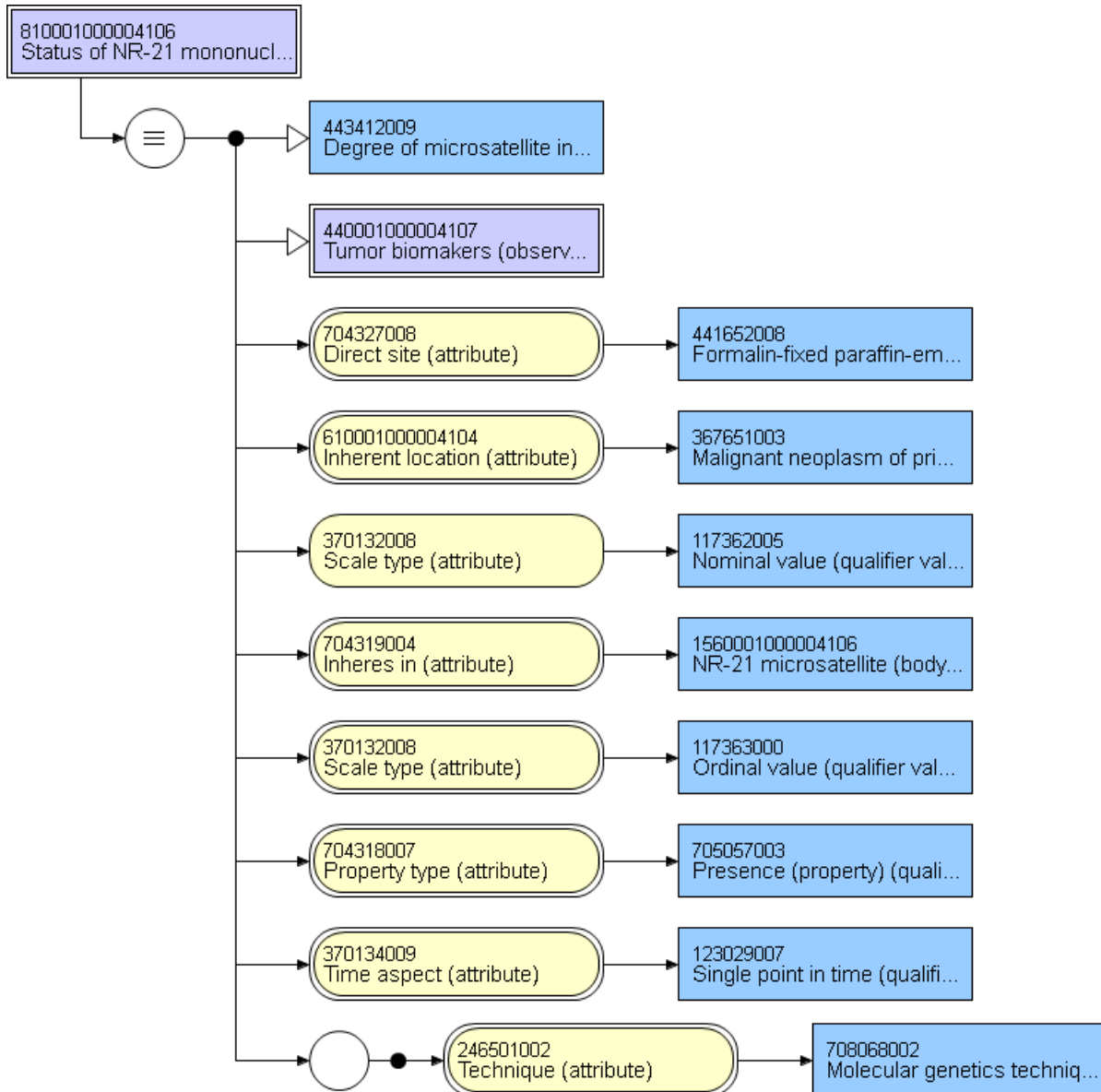

<b>NR-24 Loci stability</b>	<b>81700-7 - Microsatellite instability marker NR24 in Cancer Qualitative</b>	
	Stable	58158008   Stable (qualifier value)
	Unstable	263922001   Unstable status (qualifier value)
	Undetermined (explain): _____	373068000   Undetermined (qualifier value)

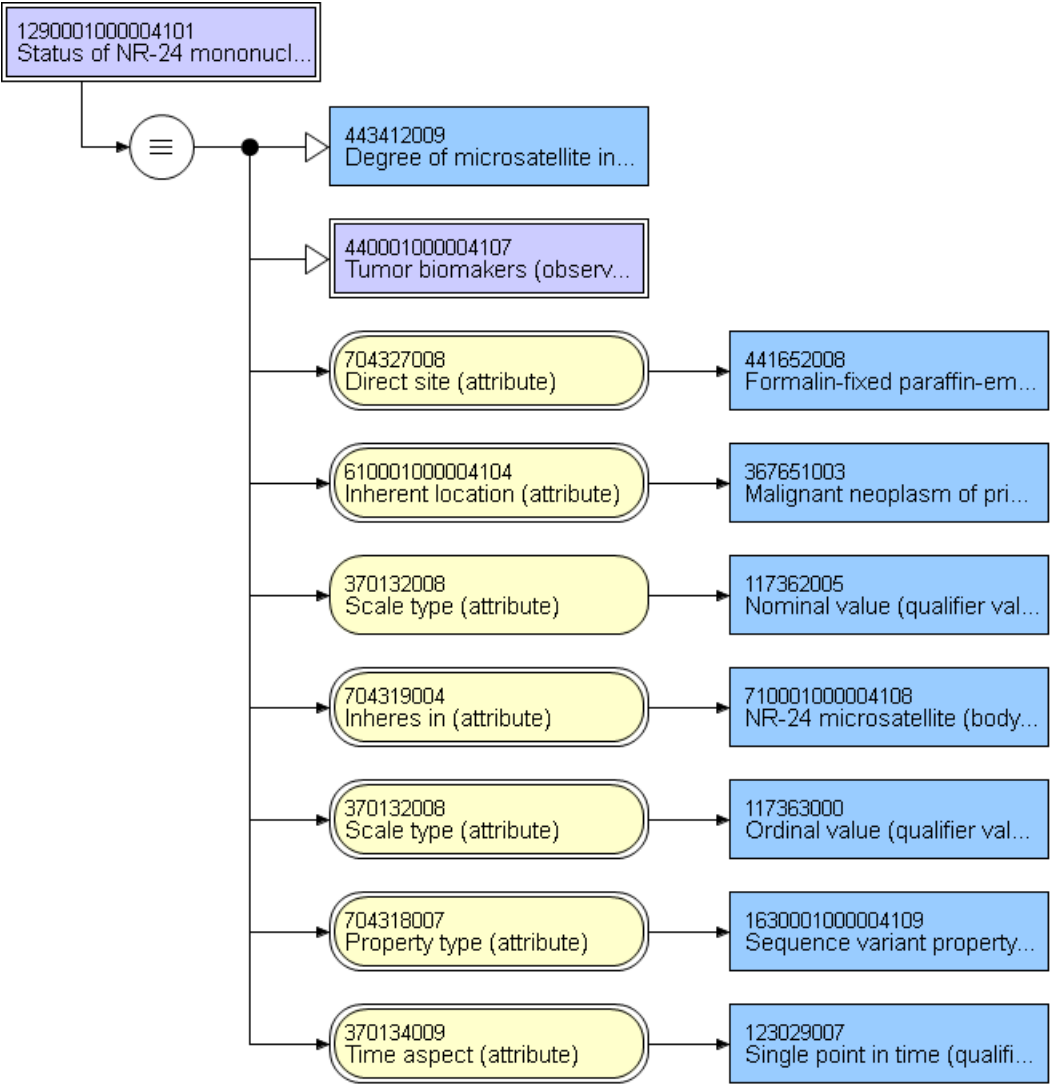

<b>Mono-27</b>	<b>81701-5 -</b>	
<b>Loci stability</b>	<b>Microsatellite instability marker MONO27 in Cancer Qualitative</b>	
	Stable	58158008   Stable (qualifier value)
	Unstable	263922001   Unstable status (qualifier value)
	Undetermined (explain): _____	373068000   Undetermined (qualifier value)

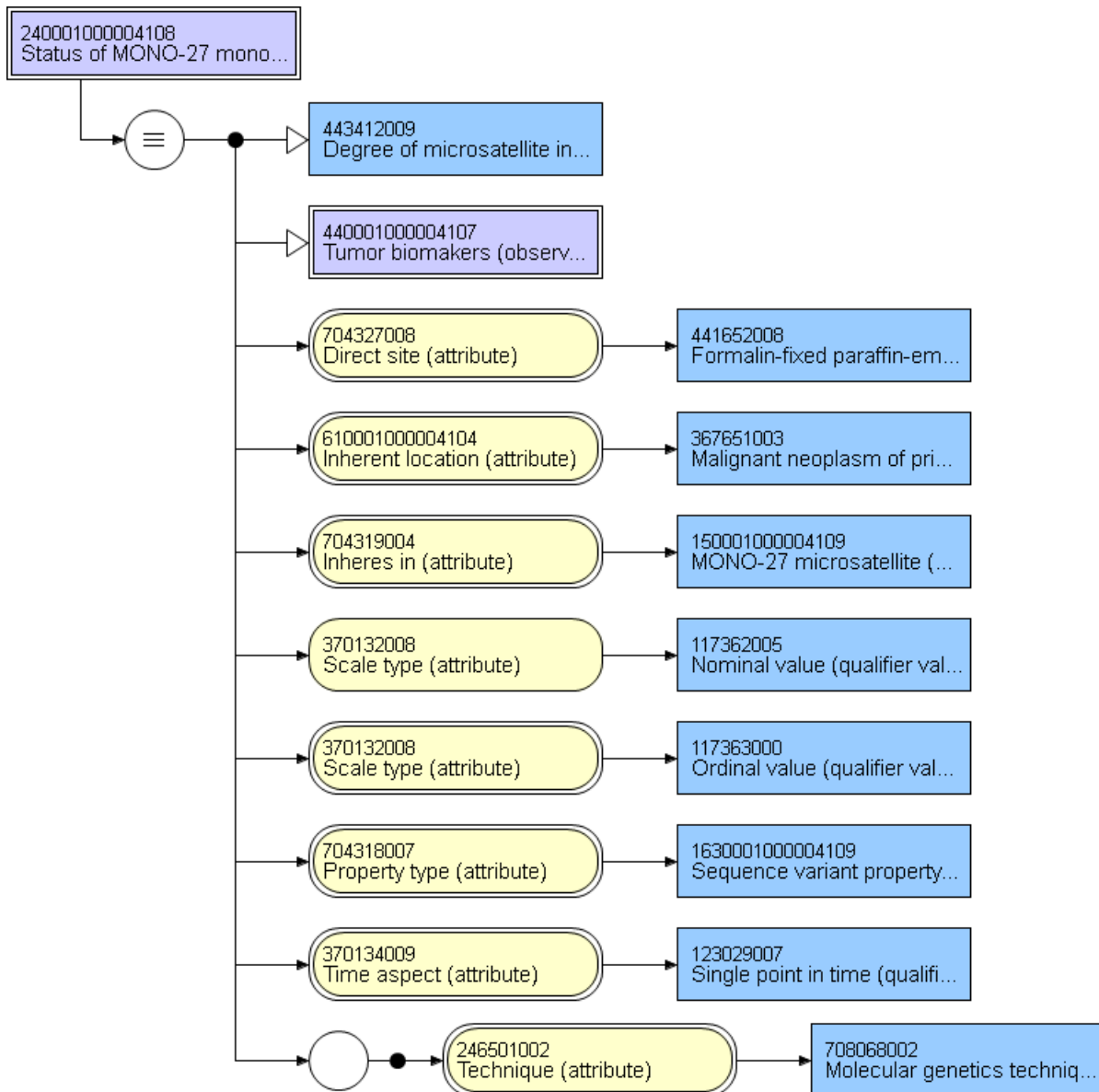

<b>D2S123 Loci stability</b>	<b>81702-3 - Microsatellite instability marker D2S123 in Cancer Qualitative</b>		
	Stable	58158008   Stable (qualifier value)	
	Unstable	263922001   Unstable status (qualifier value)	
	Undetermined (explain): _____	373068000   Undetermined (qualifier value)	

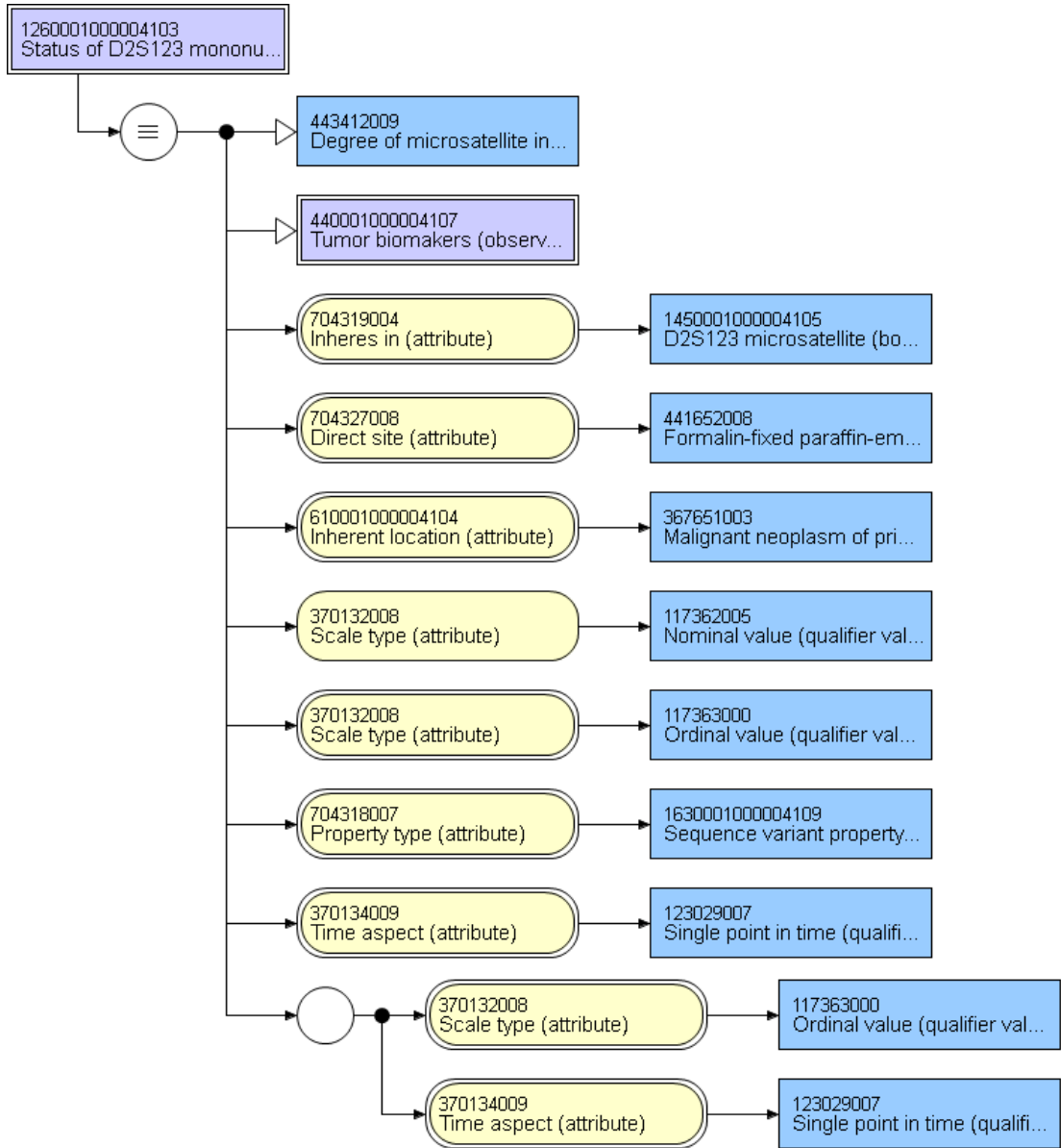

<b>D5S346 Loci stability</b>	<b>81703-1 - Microsatellite instability marker D5S346 in Cancer Qualitative</b>	
	Stable	58158008   Stable (qualifier value)
	Unstable	263922001   Unstable status (qualifier value)
	Undetermined (explain): _____	373068000   Undetermined (qualifier value)

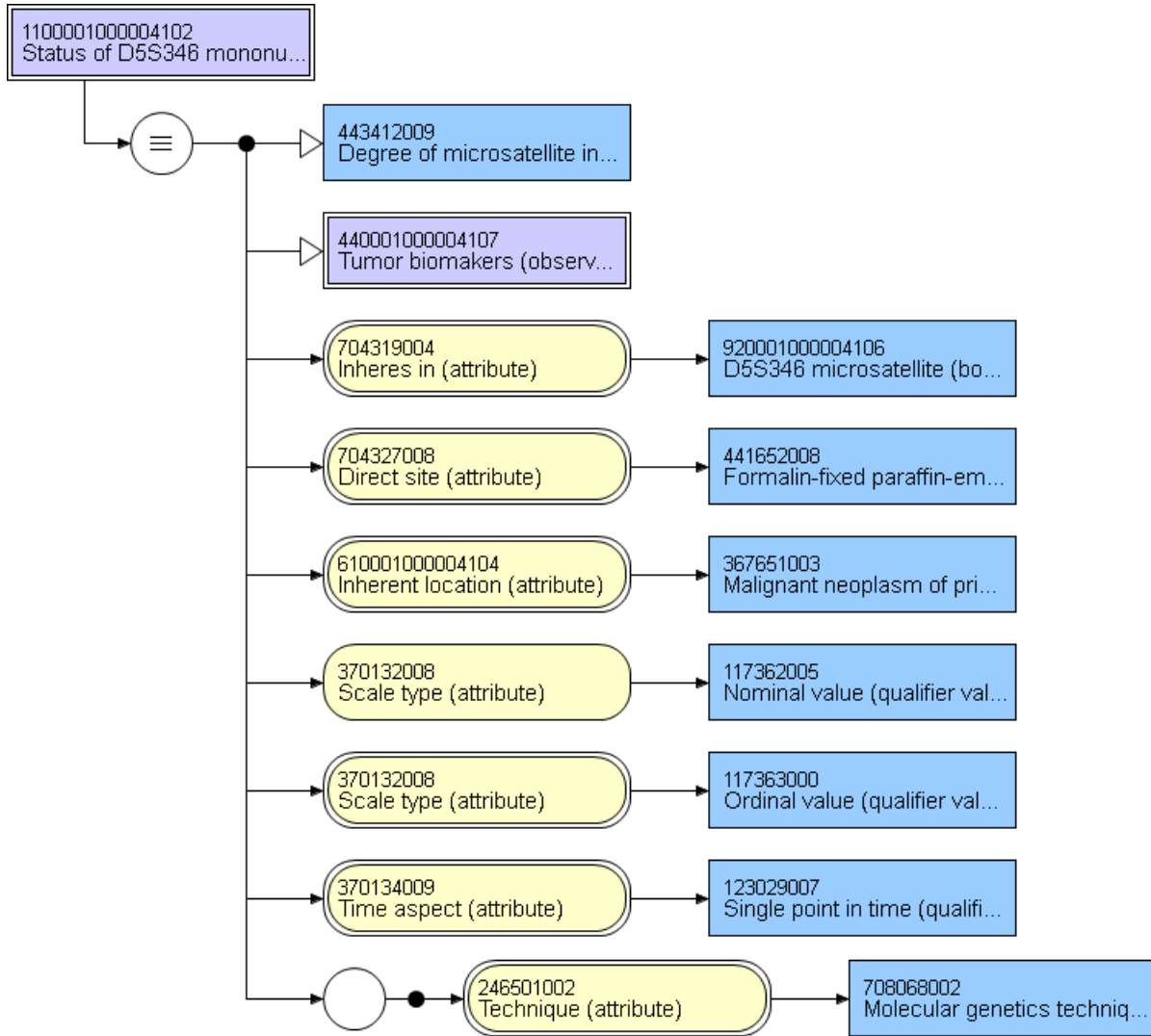

<b>D17S250 Loci stability</b>	<b>81704-9 - Microsatellite instability marker D17S250 in Cancer Qualitative</b>	
	Stable	58158008   Stable (qualifier value)
	Unstable	263922001   Unstable status (qualifier value)
	Undetermined (explain): _____	373068000   Undetermined (qualifier value)

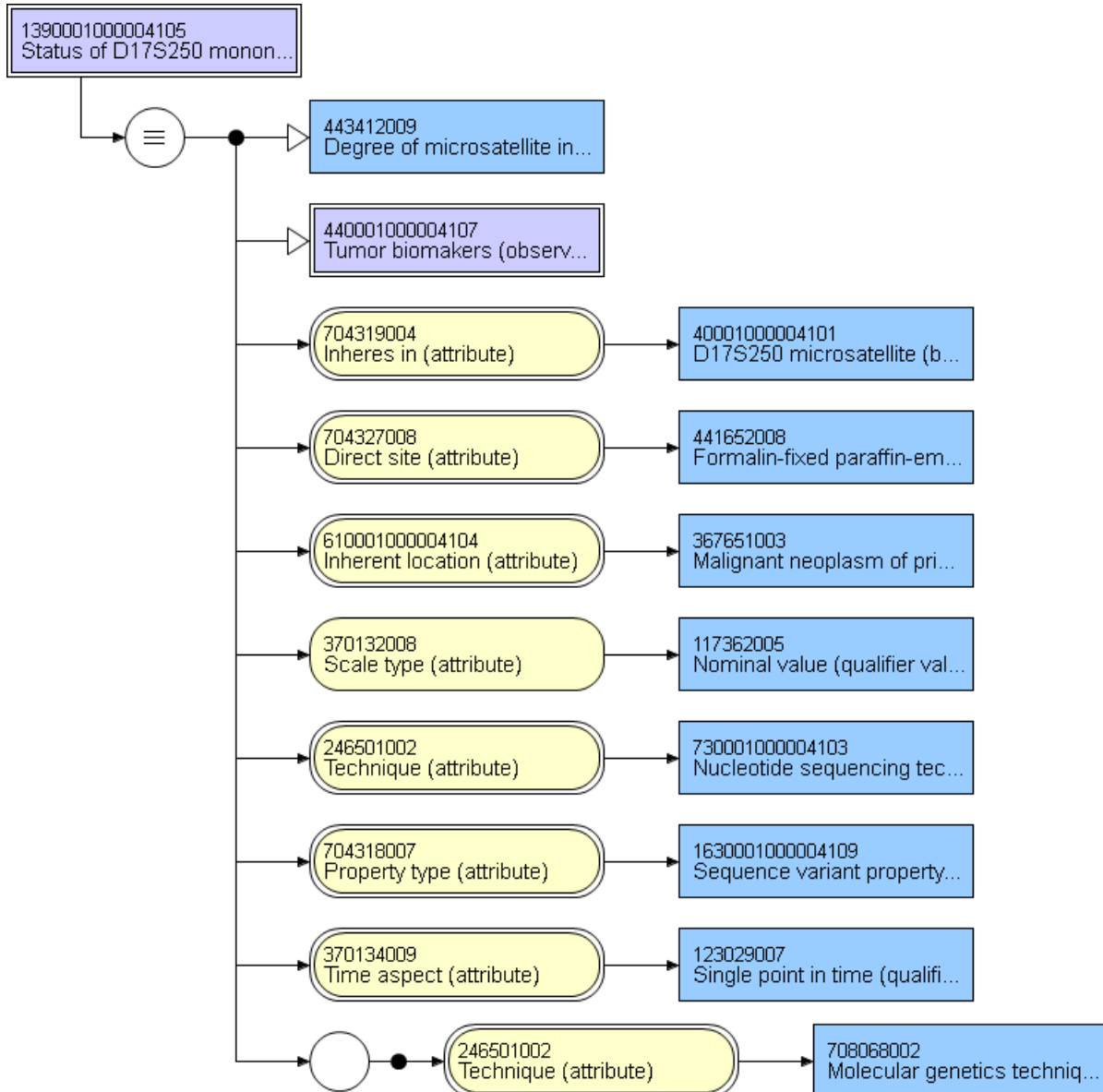

<b>MLH1 Promotor Methylation Analysis</b>	<b>58416-9 - MLH1 gene methylation [Presence] in Tissue by Molecular genetics method</b>	
	MLH1 promoter hypermethylation present	52101004   Present (qualifier value)
	MLH1 promoter hypermethylation absent	2667000   Absent (qualifier value)
	Undetermined (explain):	373068000   Undetermined (qualifier value)

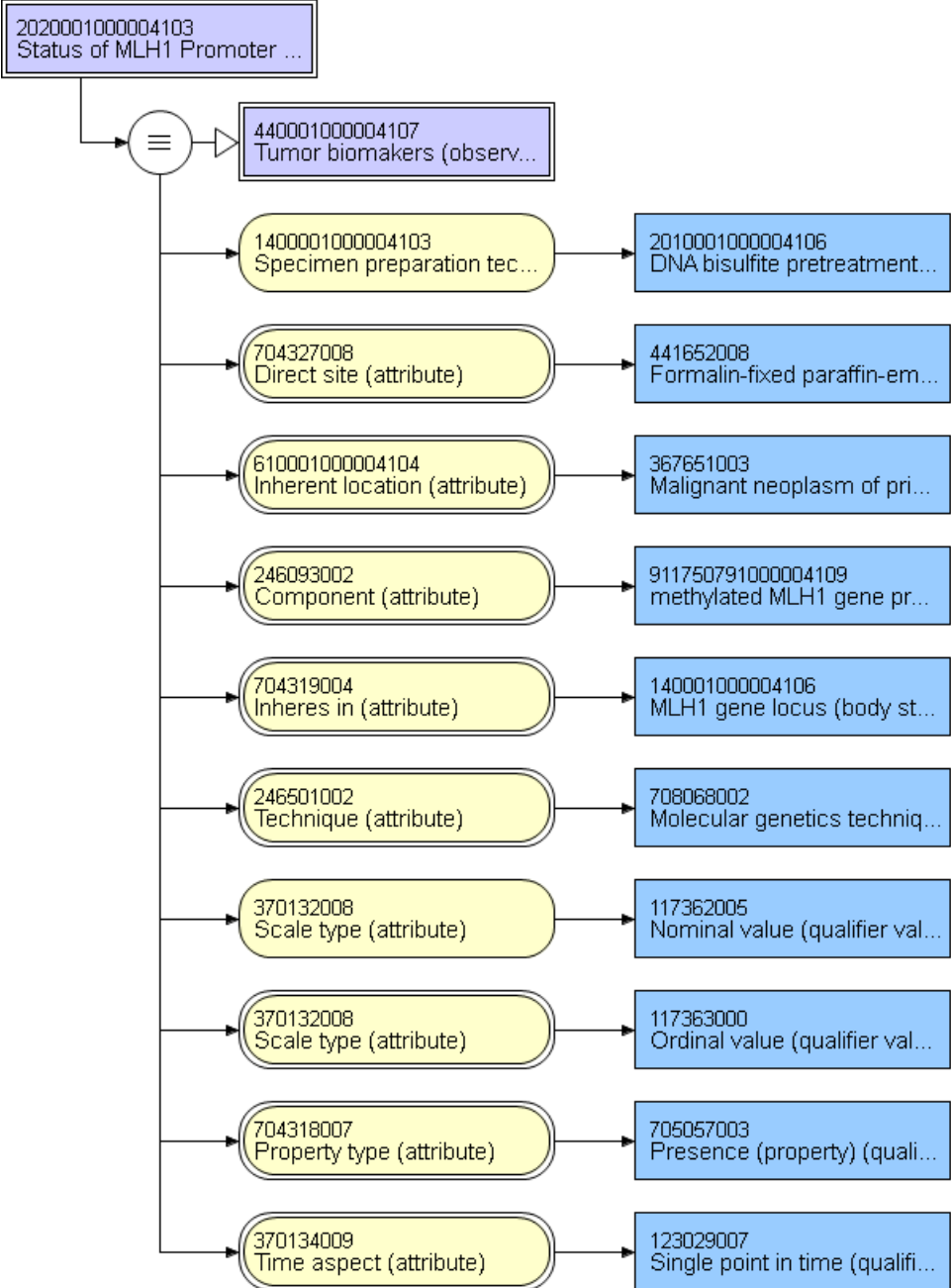

KRAS Mutation Identified		
	No sequence variant identified	NM_004985 c.(=)
	Gly12Asp (GGT>GAT)	NM_004985.4(KRAS):c.35G>A (p.Gly12Asp)
	Gly12Val (GGT>GTT)	
	Gly12Cys (GGT>TGT)	
	Gly12Ser (GGT>AGT)	
	Gly12Ala (GGT>GCT)	
	Gly12Arg (GGT>CGT)	
	Other Codon 12 mutation (specifiy): _____	
	Gly13Asp (GGC>GAC)	
	Gly13Arg (GGC>CGC)	
	Gly13Cys (GGC>TGC)	
	Gly13Ala (GGC>GCC)	
	Gly13Val (GGC>GTC)	
	Other Codon 13 mutation (specifiy): _____	
	Gln61Leu (CAA>CTA)	
	Gln16His (CAA>CAC)	
	Other Codon 16 mutation (specifiy): _____	
	Ala146Thr (G435A) (GCA>ACA)	
	Other Codon 146 mutation (specifiy): _____	
	Other Codon mutation (specifiy): _____	

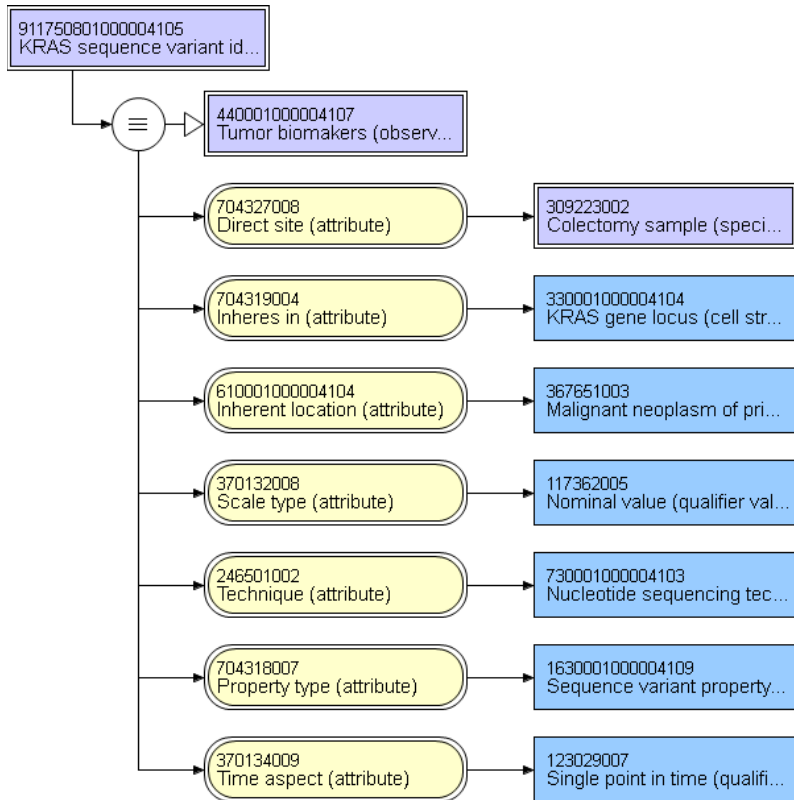



NRAS Mutation Identified			
		Gly12Asp (GGT>GAT)	
		Gly12Val (GGT>GTT)	
		Gly12Cys (GGT>TGT)	
		Gly12Ser (GGT>AGT)	
		Gly12Ala (GGT>GCT)	
		Gly12Arg (GGT>CGT)	
		Other Codon 12 mutation (specifiy):_____	
		Other Codon 13 mutation (specifiy):_____	
		Gln61Lys (CAA>AAA)	
		Gln61Arg (CAA>CGA)	
		Other Codon 61 mutation (specifiy):_____	
		Other Codon mutation (specify): _____	

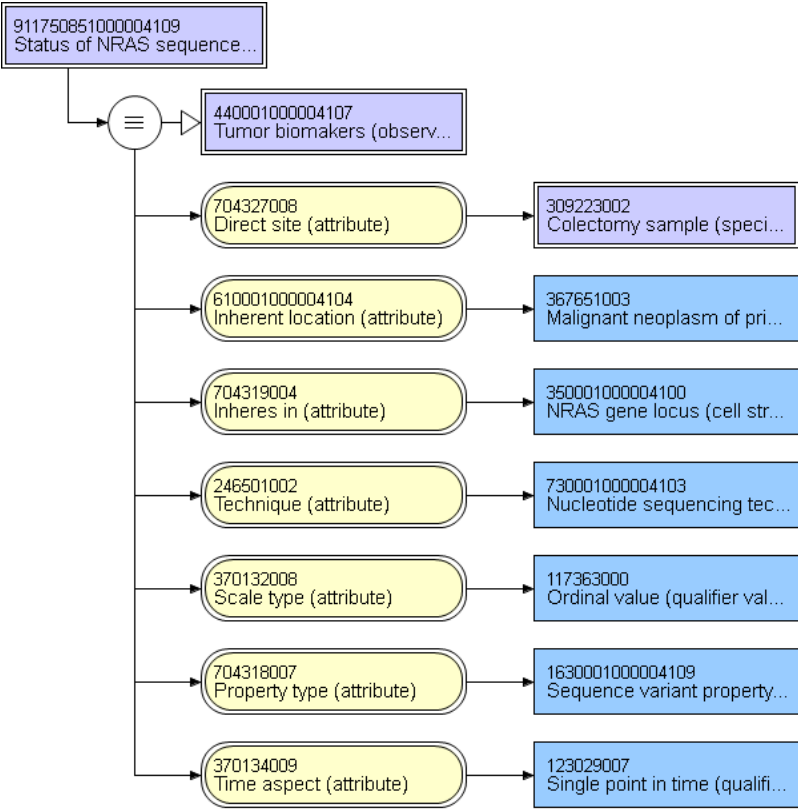

<b>BRAF Expression by IHC</b>	<b>81705-6 - Serine-threonine protein kinase B-raf [Presence] in Cancer by Immune stain</b>	
	Positive cytoplasmic expression	318120301000004107   Positive genetic protein expression in cytoplasm of cell (finding)
	Negative cytoplasmic expression	307815691000004106   Loss of genetic protein expression in cytoplasm of cell (finding)
	Undetermined (explain) :	373068000   Undetermined (qualifier value)

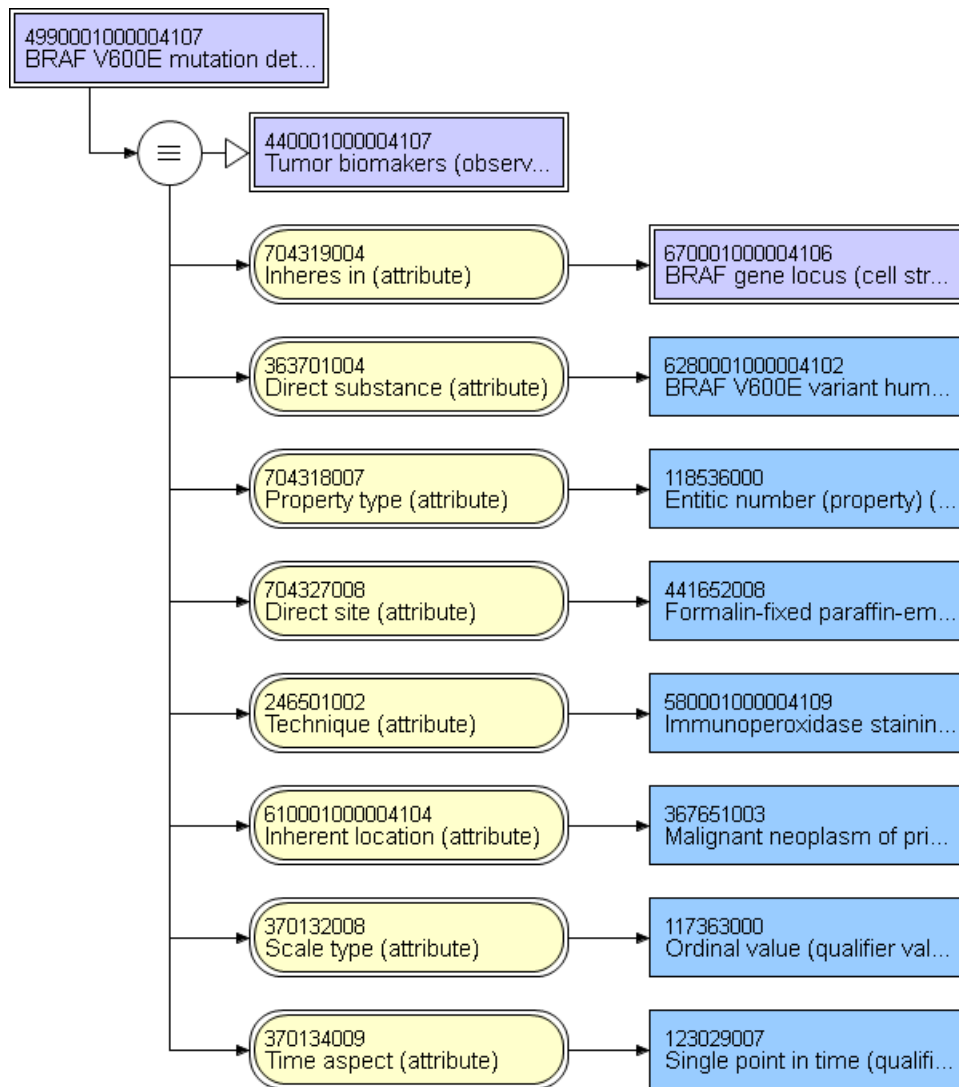

<b>BRAF Mutational identified</b>			
		BRAF V600E mutation	843509901000004102   BRAF V600E mutation identified in excised malignant neoplasm (finding)
		Other BRAF mutation (specify):	

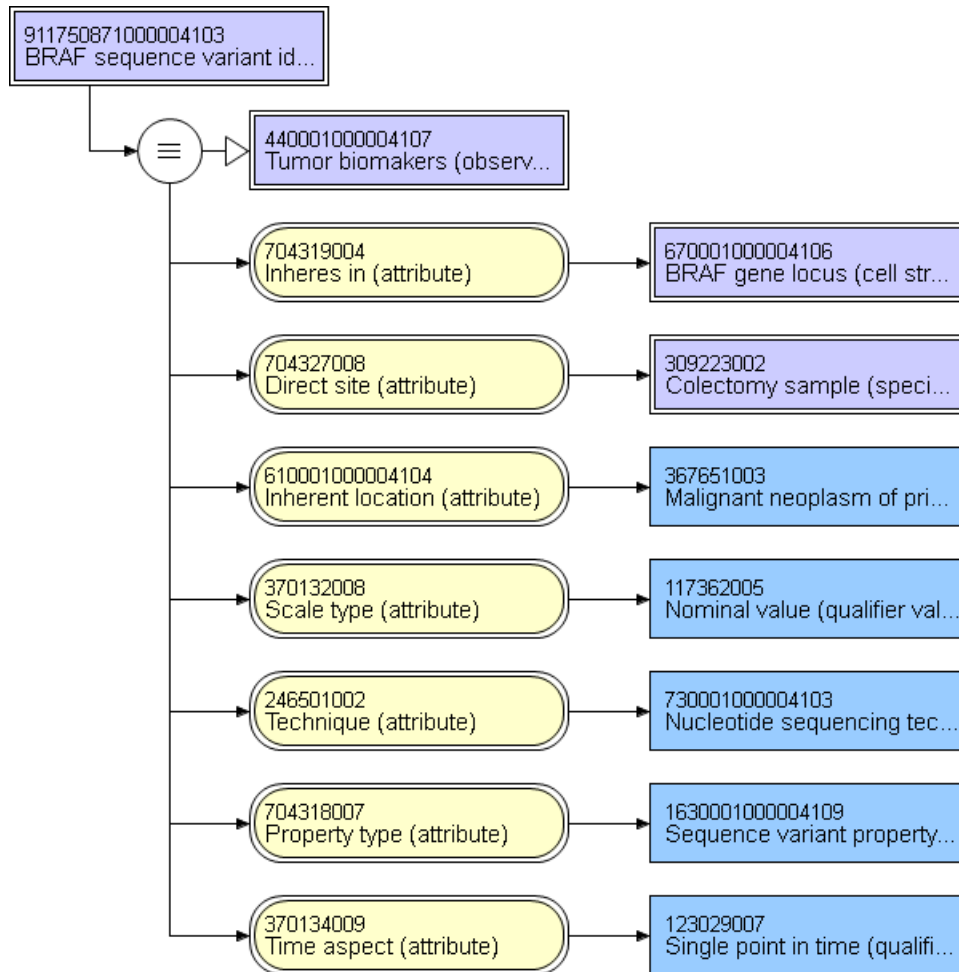

<b>PIK3CA Mutation Identified</b>			
		Exon 9 mutation (specify):	
		Exon 20 mutation (specify):	

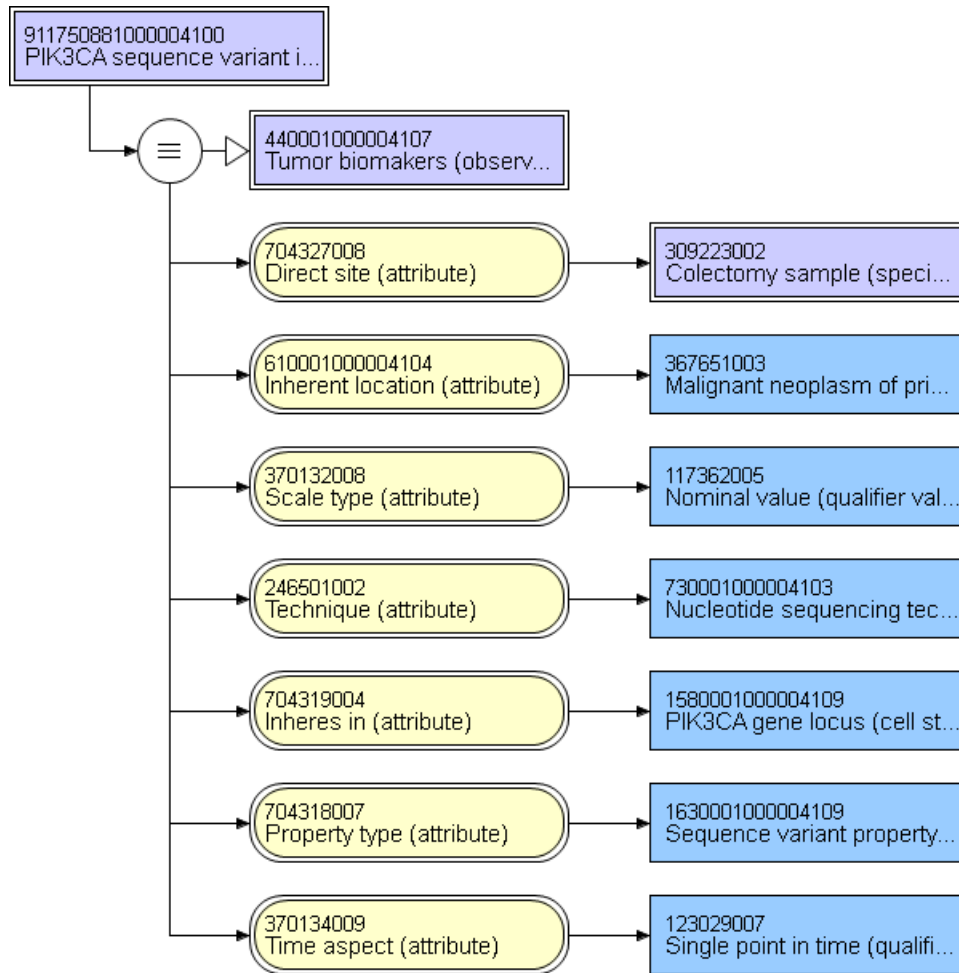

<b>PTEN Expression by IHC</b>	<b>81706-4 - Phosphatase and tensin homolog (PTEN) protein [Presence] in Cancer by Immune stain</b>	
	Positive for cytoplasmic and/or nuclear expression	826864521000004106   Positive gene expression in cell (finding)
	Negative for cytoplasmic and/or nuclear expression	62582271000004100   Negative gene expression in cell (finding)
	Undetermined (explain) :	373068000   Undetermined (qualifier value)

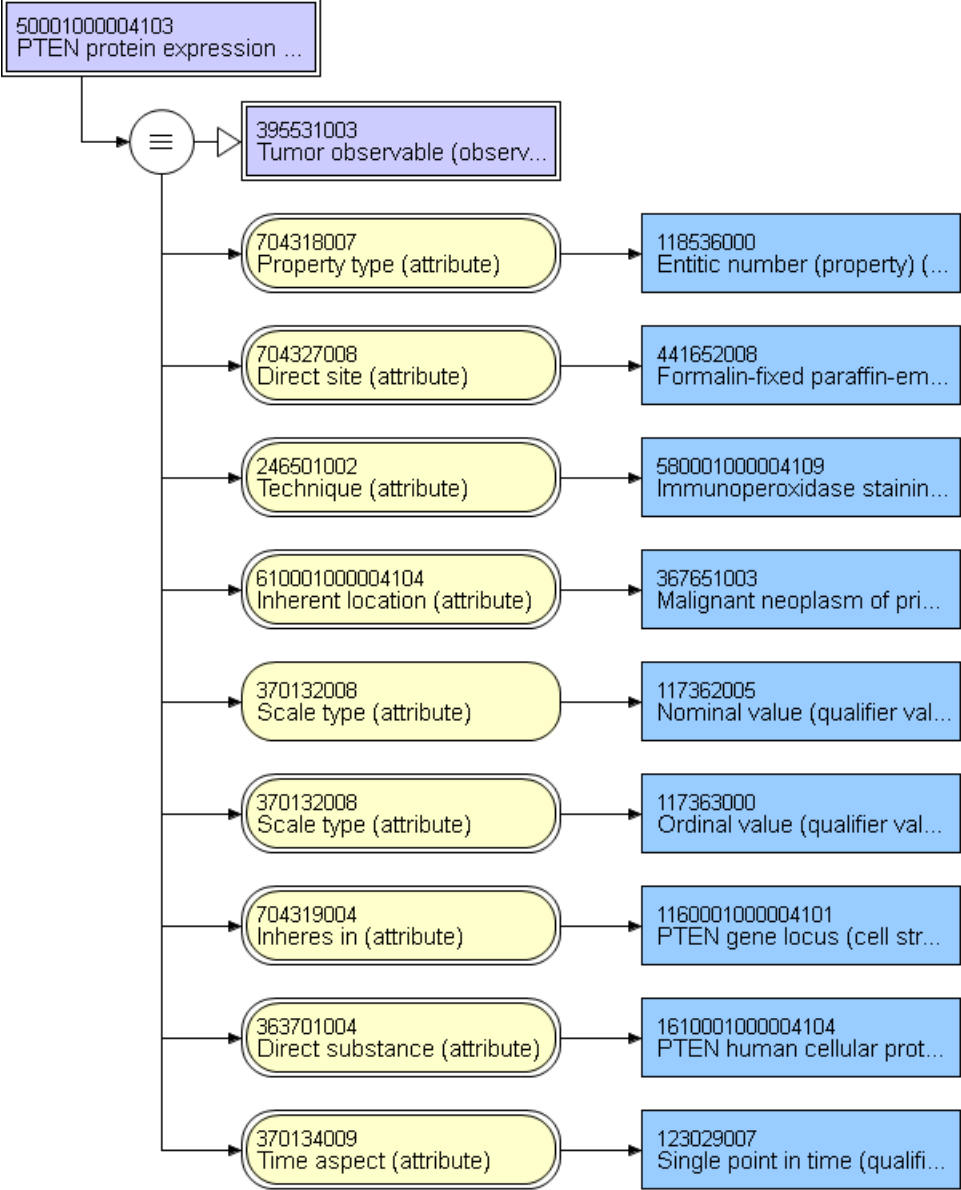

<b>PTEN Mutation Identified</b>			
		Exon 1-9 mutation (specify):	

911750921000004109  
PTEN sequence variant id...

